

CSIRO Publishing

Invertebrate Systematics

Continuing *Invertebrate Taxonomy*



Volume 16, 2002
© CSIRO 2002

All enquiries and manuscripts should be directed to:



Invertebrate Systematics
CSIRO Publishing
PO Box 1139 (150 Oxford St)
Collingwood, Vic. 3066, Australia

Telephone: +61 3 9662 7629

Fax: +61 3 9662 7611

Email: publishing.is@csiro.au

Published by CSIRO Publishing
for CSIRO and the Australian Academy of Science

www.publish.csiro.au/journals/is

Revision of *Sceliages* Westwood, a millipede-eating genus of southern African dung beetles (Coleoptera: Scarabaeidae)

Shaun A. Forgie^{A,B}, Vasily V. Grebennikov^A and Clarke H. Scholtz^A

^ADepartment of Zoology and Entomology, University of Pretoria, Pretoria 0002, Republic of South Africa.

^BTo whom correspondence should be addressed. Email: s.forgie@uea.ac.uk

Abstract. The genus *Sceliages* Westwood (Scarabaeinae : Scarabaeini) from southern Africa is revised. Seven species are recognised: *Sc. granulatus*, sp. nov. (Botswana, South Africa), *Sc. augias* Gillet (Angola, Democratic Republic of Congo, Zambia), *Sc. adamastor* (Le Peletier de Saint-Fargeau & Serville) (South Africa), *Sc. brittoni* zur Strassen (South Africa), *Sc. difficilis* zur Strassen (South Africa, Zimbabwe), *Sc. gagates* Shipp (South Africa, Moçambique) and *Sc. hippias* Westwood (South Africa). The new species is described and the others are redescribed. Neotypes are assigned to *Sc. adamastor* and *Sc. gagates*. A key to the species is provided and male genitalia and other diagnostic characters are illustrated. A phylogenetic analysis of the genus is presented. Distribution maps of all species are provided. Mature larvae of *Sc. hippias* are described, the first for the genus. They can be distinguished from other Scarabaeinae larvae by a markedly reduced torma on the epipharynx and complete absence of hypopharyngeal sclerites (oncyli). Millipede relocation and burial behaviour of the adults of *Sc. hippias* and *Sc. adamastor* are described. We also provide descriptions of the brood chamber and brood balls of *Sc. hippias*.

Additional keywords: biology, larva, new species, phylogeny.

Introduction

The tribe Scarabaeini contains the genera *Scarabaeus* Linnaeus, 1758, *Sceliages* Westwood, 1837, *Drepanopodus* Janssens, 1940, *Kheper* Janssens, 1940, *Pachylomerus* Kirby, 1828 and the subgenus *Scarabaeolus* Balthasar, 1965, comprising 146 species. Many of the species exhibit distinct morphological and biological variability and possess either facultative or obligate feeding strategies including necrophagy. Some of the most specialised members of this tribe belong to the genus *Sceliages*, which exclusively utilise millipedes (Diplopoda) for food and reproduction. Millipede necrophagy has long been known in the Scarabaeinae (Halffter and Matthews 1966: 25–34). Facultative opportunistic use of millipede carcasses by *Scarabaeus* (*Neateuchus* (syn.)) *proboscideus* Guérin, 1844, *S. satyrus* (Boheman, 1860) and *S.* (*Scarabaeolus*) *flavicornis* (Boheman, 1860), has been observed by some of us (S. A. Forgie and C. H. Scholtz, unpublished data). Necrophagy of millipedes has also been recorded in several species in two other tribes. In the Onthophagini, several

species of *Onthophagus* Latreille, 1802, including *O. bicavifrons* d'Orbigny, 1902 and *O. latigibber* d'Orbigny, 1902, were attracted to fresh millipede carcasses (Krell *et al.* 1997; Krell 1999). Neotropical canthonines, *Canthon cyanellus cyanellus* Le Conte, 1859 and *C. morsei* Howden, 1966, utilise both live injured and dead diplopods (Villalobos *et al.* 1998), whereas *Deltochilum kolbei* Paulian, 1938 (Halffter and Matthews 1966) and *D. valgum acropyge* Bates, 1877 (Cano 1998) are known to actively prey on live millipedes.

In southern Africa, many animals prey on millipedes (see Lawrence 1987: 82, 89–90). For example, adult and nymphal reduviid bugs (Hemiptera : Reduviidae), such as *Ectricodia crux* (Thunberg, 1783), *Cleptria cinctiventris* Stål, 1855 and nymphs of the genus *Glymmatophora* Stål, 1853, frequently specialise in preying on *Doratogonus* Attems, 1914, a spirostreptid, but they have never been recorded preying on species of the genus *Centrobolus* Cook, 1897 (Lawrence 1987). Various quinone-based defensive allomones are secreted particularly in spirobolid and spirostreptid millipedes to repel attack by predators (Krell *et al.* 1998).

Two species of the orders Spirostreptida and Julida were found to use quinonous defensive secretions as pheromones (Haacker 1974), which is likely to be a secondary function for many species of millipedes using these secretions. Necrophagous onthophagine scarabaeids are reported to be attracted to millipede secretions used as repellents (Krell *et al.* 1997, 1998; Krell 1999) and are also likely to be attracted to the quinonous secretions used as pheromones by millipedes during copulation (Kon *et al.* 1998). Positive chemotaxis to the defensive secretions of millipedes by *Sceliages* has not been tested prior to this study. Live (Krell 1999; S. A. Forgie, unpublished data), injured and freshly dead millipedes all attract *Sceliages*, suggesting quinone-based secretions play a role in attracting these beetles. *Sceliages* have also been collected by Endrödy-Younga in traps containing meat/carrion, horse dung and fruit, and observed rolling antelope dung pellets (Mostert and Scholtz 1986:10). However, the observation recorded by Mostert and Scholtz (1986) is best described as aberrant behaviour for the genus or more likely the product of misidentification of the beetle responsible. Likewise, the records of *Sceliages* trapped in long-term ground traps baited with various ingredients by Endrödy-Younga are possibly misleading. For example, in this case, *Sc. brittoni* may have become trapped inadvertently after being attracted to millipedes that might have stumbled into the traps.

With the description of the new species herein, there are now seven species in the genus *Sceliages*, all restricted to southern Africa. Members of the genus are rarely encountered in the wild and are likely to be mistaken for *Scarabaeus* L. Furthermore, specimens of *Sceliages* are rare in collections and often misidentified or unidentified. The biology of *Sceliages* has, to date, not been studied. Zur Strassen's (1965) revision of the genus is the precedent for this study. It was based on relatively few specimens held in several museums in Europe and southern Africa. In his introduction, zur Strassen mentioned that encounters of generic misidentifications of a number of specimens in museum collections reflected that the genus *Sceliages* was not well known and the descriptions of the oldest species were very deficient. Zur Strassen (1965) also pointed out that the situation had been exacerbated by later authors, who had described known species as new because they were unaware of the already described species. In addition, and in accordance with zur Strassen (1965), the holotypes of *Sc. Adamastor* and *Sc. gagates* could not be located and may be considered non-existent. As a result, we have assigned a neotype for each of these species.

In this paper we report the results of our review, present a phylogenetic analysis of the genus and describe a new species from the semi-arid western parts of the region. Moreover, we provide for the first time a larval description of one species and give details of the remarkable biology of members of the genus feeding on Diplopoda.

Taxonomy and biology

Materials and methods

Adult material examined

A complete list of the material examined is available as 'Accessory Material' on the *Invertebrate Systematics* web page (<http://www.publish.csiro.au/journals/is>).

The institutions to which the specimens belong are abbreviated as follows.

- BMNH The Natural History Museum, Department of Entomology, Cromwell Road, London SW7 5BD, UK.
- DMSA Durban Museum, PO Box 4085, Durban 4000, South Africa.
- HECO Hope Entomological Collections, Oxford University Museum of Natural History, Parks Road, Oxford OX1 3PW, UK.
- ISNB Institut Royal des Sciences Naturelles de Belgique, Département d'Entomologie, Rue Vautier 29, B-1000 Bruxelles, Belgium.
- SAMC South African Museum, PO Box 61, Cape Town 8000, South Africa.
- SANC The National Collection of Insects, Plant Protection Research Institute, Private Bag X134, Pretoria 0001, South Africa.
- TMSA Museum of Natural History (Transvaal Museum), Northern Flagship Institution, PO Box 413, Pretoria 0001, South Africa.
- UPSA University of Pretoria, Department of Zoology and Entomology, Pretoria 0002, South Africa.

Latitude and longitude coordinates for all specimens where full information was available were utilised for the distribution maps of each species. Locality information in parentheses represents the current recognised localities and also information not listed on the specimen collection data labels. A question mark in parentheses immediately precedes a locality data item that could not be interpreted. Inverted commas surround exact wording taken from specimen collection data labels. Some latitude and longitude coordinates were obtained from material examined sections of zur Strassen (1965) for *Sceliages augias* Gillet, 1908 and are included in the distribution map (Fig. 82) for this species.

Distribution maps. Map coordinates were obtained either directly from specimen collection data labels or by submitting specimen localities into GeoName™ digital gazetteer (GDE Systems, Inc., <http://gnpswww.nima.mil/geonames/GNS/index.jsp>) software. These coordinates were converted to decimal degrees and plotted as distribution maps using ArcView® GIS software (Environmental Systems Research Institute, Inc., Redlands CA, USA).

Male genitalia. Aedeagi were removed from 21 specimens (*Sc. granulatus*: 1 holotype SANC, 4 paratypes SANC, 1 paratype UPSA; *Sc. hippias*: 1 TMSA, 1 SANC; *Sc. augias*: 1 BMNH; *Sc. adamastor*: 1 TMSA; *Sc. brittoni*: 1 SANC, 1 TMSA; *Sc. difficilis*: 3 SANC, 1 UPSA, 3 TMSA; *Sc. gagates*: 2 SANC), and soaked in warm 10% KOH for c. 15 minutes. The internal sacs were extracted, stretched out and allowed to soak in warm 10% KOH for a further 5 minutes. Sacs were soaked successively in distilled H₂O, 70% EtOH, distilled H₂O prior to their preservation in glycerine. Virgular sclerites (Matthews 1974) were dissected from the internal sacs and placed in drops of glycerine on glass slides for examination under a stereomicroscope.

Larval material examined

Five mature larvae of *Sceliages hippias* originated from brood balls collected together with females. Two larvae with one female were collected on 17 December 2000 at the Rustenburg Nature Reserve

(25°40'S 27°12'E), NW Province, Republic of South Africa by S. Forgie and V. Grebennikov. Three more larvae with one female were collected on 12 January 2001 from the same locality and by the same collectors. Voucher larvae and females are deposited in UPSA and BMNH.

Sceliages larvae were preserved in Bouin's liquid for a week and then transferred into 70% ethanol. Two larvae were disarticulated as follows. The head, left legs, mandibles and the labio-maxillar complex were separated and cleaned in a hot water solution of KOH. Separated parts were transferred into glycerol and studied under dissecting and compound microscopes. Morphological drawings were prepared using camera lucida. The morphological terms utilised in this description are those explained by Böving (1936), Ritcher (1966) and Lawrence (1991). Exception is made for terms applicable to the secondary thoracic and abdominal subdivisions; instead of 'prescutum', 'scutum' and 'scutellum', we use 'dorsal lobes' as explained in Baker (1968: 13). For comparative purposes, one larva of each of the following Scarabaeinae genera was studied as described in the 'Materials and methods' section: *Circellium bacchus* Fabricius, 1785; *Heliocopris andersoni* Bates, 1868; *Kheper nigroaeneus* (Boheman, 1857); *Scarabaeus galenus* (Westwood, 1847); *Scarabaeus (Pachysoma) garipepinus* (Ferreira, 1953); *S. (Pachysoma) striatus* (Castelnaud, 1840); *Synapsis imolus* (Fischer, 1821); and *Tragiscus dimidiatus* Klug, 1855.

Biology and nidification

Field study of *Sceliages hippias* was carried out at the Rustenberg Nature Reserve and *Sc. adamastor* was observed at the De Hoop Nature Reserve (34°25'S 20°24'), Western Cape Province, South Africa.

Trapping

Beetles were attracted to a series of pitfall traps baited with freshly killed millipedes unless otherwise stated. Traps were placed into the field before 0900 hours and left for no longer than one hour to minimise stress of captured beetles.

Genus *Sceliages* Westwood

Sceliages Westwood, 1837: 12. – Lacordaire, 1856: 66; Shipp, 1895: 37; Péringuey, 1901: 16, 22, 62, 63; Gillet, 1911a: 16; Ferreira, 1961: 63; Ferreira, 1967: 59–63; Ferreira, 1972: 74–78; zur Strassen, 1965: 220; Halffter & Edmonds, 1982: 138; Scholtz & Holm, 1985: 220; Mostert & Scholtz, 1986: 1, 8, 10, 11, 16, 22, 23; Hanski & Cambefort, 1991: 167, 472; Krell, 1999: 287.

Parascarabaeus Balthasar, 1961: 174. – Ferreira, 1972: 76; Mostert & Scholtz, 1986: 10.

Type species of *Sceliages*: *Sceliages iopas* Westwood, 1837 (= *S. adamastor* (Le Peletier de Saint-Fargeau & Serville, 1828)), by monotypy.

Type species of *Parascarabaeus*: *Parascarabaeus tonkineus* Balthasar, 1961, by original designation.

Diagnosis

Unique morphological characters diagnosing the genus *Sceliages* are as follows. Shape and arrangement of the four up-turned clypeal teeth (two frontal medial teeth narrow and protrude further than lateral teeth; rounded suture separates frontal medial teeth from each other; lateral teeth broad, angulate, skewed, and separated from frontal medial teeth by a sharply angled suture). Apex of mesotibia has two markedly developed spurs. Basal tarsomeres are distally flared appearing triangulate. Unique behaviour within Scarabaeini: utilisation of millipedes for feeding and breeding.

Redescription of adults

Body shape. Body mostly hunched, reminiscent of species of the *Scarabaeus (Scarabaeolus) ebenus* (Klug, 1885) group (zur Strassen 1965).

Head (Fig. 2). Clypeal margin with four up-turned teeth. Two frontal medial teeth narrow, protruding further than lateral teeth. Rounded suture separating frontal medial teeth from each other; lateral teeth broad, angulate, skewed and separated from frontal medial teeth by sharply angled suture. Genal epistomae more pronounced than lateral teeth of clypeus. Anterior lateral corner of gena tooth-like and separated from clypeus by sharply angled suture. Posterior margin of gena obtusely rounded. Geno-clypeal suture laterally present with obvious groove at its basal terminus. Surface texture of genae and clypeus shagreened and rugose with dense, often deep, punctations. Punctations simplified and less dense on frons and vertex.

Antennae. Antennal furcle consists of three segments. First segment bowl shaped; second segment much smaller, less bowl shaped, fits into first segment. Third segment sits on top of second segment.

Pronotum. Surface smooth with fine shagreen texture and covered with minute, regularly spaced punctations.

Sternites. Surface of mesobasisternum shagreened with complex punctuation of varying density and size. Margins of punctations smooth. Distal halves of metasternum and adjacent metepisternites with simple sparse punctuation. Mesosternal process markedly broad and pronounced. Markedly developed facet present between each inner margin of mesocoxal cavity and lateral carinae of mesosternellum. Width of mesosternellum between closest point separating mesocoxae greater than width of mesocoxal cavity.

Legs. Apical (fourth) denticle of protibia sickle-shaped (Figs 16–19). Antero-ventral margin of profemora adjacent to protrochanter ridged in all species and armed with at least one spur-like projection in most species (Figs 3–5). Spur present in males and females and blunted in aged specimens. Antero-ventral margin of protrochanter well defined and ridged in most species (Figs 3–5). Meso- and metatibia truncated distally (Figs 16–24). Two markedly developed mesotibial spurs present, outer spur larger than inner spur (Figs 16–19). Outer spur curved, spatulate and pointed. Inner spur evenly tapered to point. In males, dorsal truncation of distal portion of metatibia exaggerated, short and acutely fading towards medial region of tibia (Figs 14, 21, 23). Three clumps of setae present at base of metatibial truncation (Fig. 14). First clump forms row closest to truncation, comprising dense row of short, equal length setae, aligned to angle of truncation across dorsal surface of metatibia. Second clump of setae longer than first clump and positioned along metatibial margin in row transecting terminus of first clump of setae. Third clump consisting of

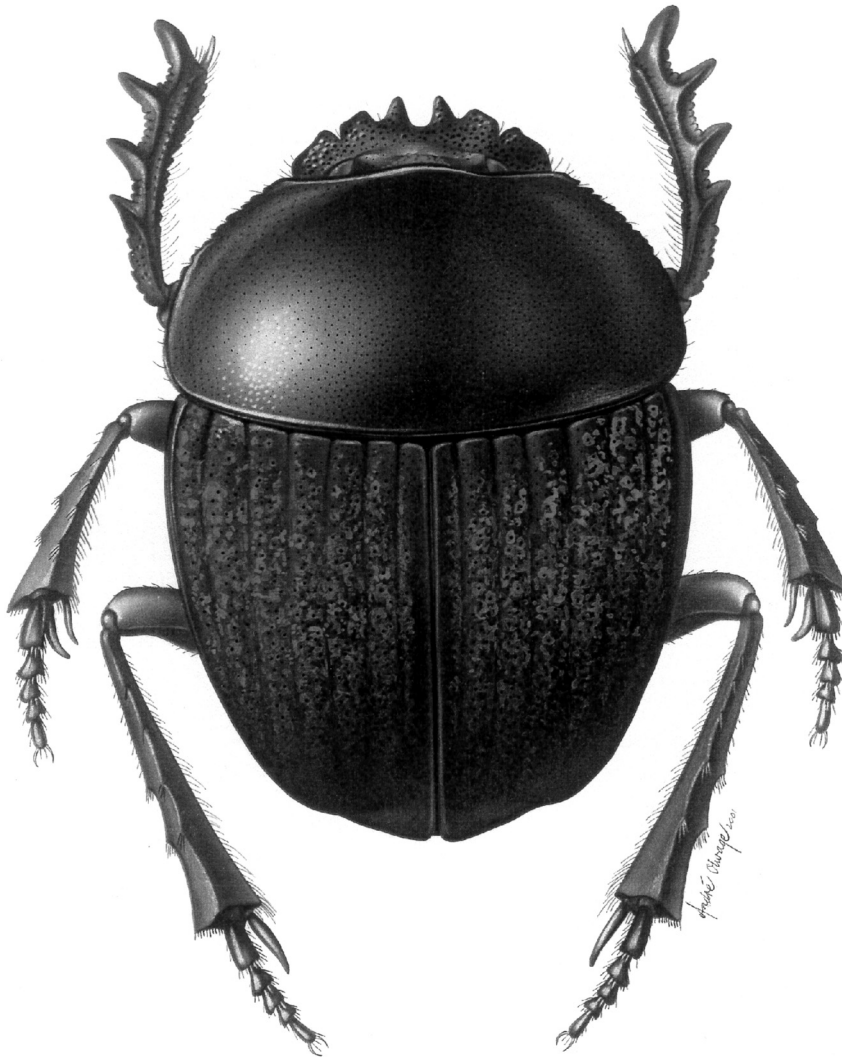

Fig. 1. *Sceliages granulatus*, habitus.

short setae positioned basally from first clump along the outer dorsal margin of metatibia. In females, metatibia broad, rectilinear, without truncation and dorsal surface lacking clumps of setae (Fig. 15). Both sexes possess uniform row of setae running uninterrupted medially along length of inner metatibial surface (Fig. 20). Setae often arise from medial longitudinal carina or margin that defines the setal row. Basal tarsomeres flared distally appearing triangular in dorsal and ventral perspectives.

Male genitalia (Figs 6–13). Ventral structure, or handle, of virgular sclerite completely fused with primary sclerotised circular ring. Apical region of handle upturned with varying degree and twisted so that apex is approximately perpendicular to plane of basal region.

Remarks

Ateuchus adamastor was first described by Le Peletier de Saint-Fargeau and Serville in 1828. In 1837, Westwood

described the genus *Sceliages* (based on the species *Sc. iopas*) to differentiate species of *Scarabaeus*, including those of the genus *Ateuchus* Weber, which possess several 'structural peculiarities' including two mesotibial spurs. Both Westwood (1837) and Lacordaire (1856) thought *A. adamastor* should belong to the genus *Sceliages*, presumably without realising *A. adamastor* was conspecific with *Sc. iopas*. Synonymy of both species under the new combination *Sceliages adamastor* (Le Peletier de Saint-Fargeau & Serville, 1828) was formalised by Shipp (1895). The genus *Ateuchus* was described by Weber in 1801 without the designation of a type species and in 1901 Péringuey designated it a synonym of *Scarabaeus*. Currently, only *Ateuchus* appears as a new world genus within the tribe Coprini (Halffter and Edmonds 1982).

As far as we are aware, Ferreira (1972: 76) is the first author to cite *Parascarabaeus* Balthasar, 1961 as a synonym of *Sceliages*. However, Mostert and Scholtz (1986: 10–11)

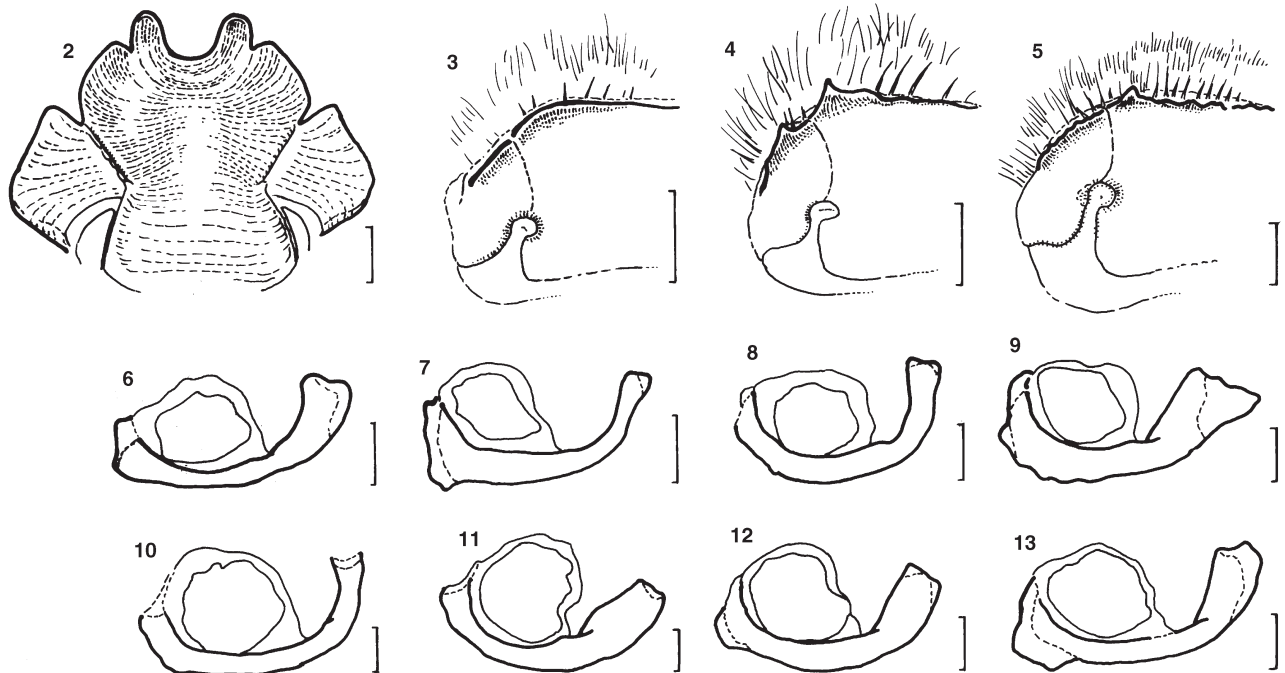

Fig. 2–13. 2, Head plates of *Sceliages*, contour. 3–5, Profemora and prothrochanter; development of basal region of antero-ventral margin (ventral perspective). Scale bars: 1 mm. 3, *Sceliages hippias*; 4, *Sc. augias*; 5, *Sc. brittoni*. 6–13, Male genitalia of *Sceliages*; virgular and circular sclerites of the internal sac, contour. Scale bars: 0.2 mm. 6, *Sceliages granulatus* (Sekoma, Botswana); 7, *Sc. granulatus* (Kimberley, RSA); 8, *Sc. hippias*; 9, *Sc. augias*; 10, *Sc. brittoni*; 11, *Sc. adamastor*; 12, *Sc. difficilis*; 13, *Sc. gagates*.

later proposed that the type species of *Parascarabaeus tonkineus* is likely to be a mislabelled specimen of *Sceliages* since all other specimens of *Sceliages* have been collected only in the southern half of the African continent. Nonetheless, its status remains as the only full generic synonym of *Sceliages* to date (Mostert and Scholtz 1986).

Regarding the morphological differentiation of the genus, a second medial/inner mesotibial spur is also present in the *Scarabaeus* subgenus *Scarabaeolus* Balthasar, 1965, but this differs from *Sceliages* in being vestigial and difficult to locate (e.g. zur Strassen 1967: 130).

Key to the species of the genus *Sceliages* Westwood

- 1. Protibia slightly and evenly increasing in width distally; with slight to no inward angulation on medial facet at level of second external denticle (angulation less apparent in females) (Figs 25–32, 42–45) 2
- Protibia abruptly increasing in width distally at level between second and third external denticle; with markedly developed inward angulation of medial facet at level from third external denticle to between third and halfway to second external denticle (angulation less apparent in females) (Figs 33–41) 5
- 2(1). Elytra surface complex, obvious corrugation or granulation; course shagreen texture; waxy indumentum present; general matt appearance; striae well defined, bordered with microcarinae 3

- Elytra surface plain, without obvious surface protuberances; fine shagreen texture, waxy indumentum usually absent, general glossy appearance; striae fine, narrow and grooved 4
- 3(2). Elytra surface covered in dense, raised granulations *Sc. granulatus*, sp. nov.
- Elytra surface longitudinally corrugated; tops of corrugations smooth, glossy, providing a striped or ribbed appearance *Sc. augias* Gillet
- 4(3). Antennae yellow–orange; posterior facet of mesofemora armed with single row of long setae closely paralleling ventral margin (Fig. 47); medial facet of mesotibia straight (Fig. 18) *Sc. hippias* Westwood
- Antennae brown–black; posterior facet of mesofemora armed with two to three rows of setae (Figs 54, 55); first row closely paralleling ventral margin; second and third row (if present) with reduced setation, from a few to several setae; medial facet of mesotibia slightly curved inwards *Sc. gagates* Shipp
- 5(1). Obtuse inward angulation of medial facet of protibia from third external denticle (Figs 33–36); protibial width (in dorsal perspective) broadens abruptly in apical quarter; elytra surface glossy; striae on elytra fine, narrow grooved 6
- Slight inward angulation of medial facet of protibia from between third and half way to second external denticle (Figs 37–41); protibial width (in dorsal perspective) slightly increased in apical quarter; elytra surface matt with thin waxy indumentum; striae on elytra well defined, often bordered with microcarinae (more apparent in teneral adults) *Sc. difficilis* zur Strassen
- 6(5). Setation red; mesotibia slightly bowed (Fig. 16); outer mesotibial spur elongate to approximately 1/2 length of

mesotibia (Fig. 16); medial facet of metatibia (in dorsal perspective) relatively straight (Fig. 23)
 *Sc. brittoni* zur Strassen
 Setation black; mesotibia obtusely bowed (Fig. 17); outer mesotibial spur 1/5 to 1/4 length of mesotibia (Fig. 17); entire metatibia bowed inwards (Figs 21, 22)
 . . . *Sc. adamastor* (Le Peletier de Saint-Fargeau & Serville)

Sceliages adamastor (Le Peletier de Saint-Fargeau & Serville)

(Figs 11, 17, 21, 22, 35, 36, 50, 51, 83)

Ateuchus adamastor Le Peletier de Saint-Fargeau & Serville, 1828: 351. – Westwood, 1837: 12; Lacordaire, 1856: 66; Shipp, 1895: 38.

Sceliages adamastor (Le Peletier de Saint-Fargeau & Serville). – Shipp, 1895: 38; Péringuey, 1901: 63; Felsche, 1910: 339; Gillet, 1911a: 16; Ferreira, 1961: 63; Ferreira, 1967: 60; Ferreira, 1972: 77; zur Strassen, 1965: 220, 228, 229, 231; Halffter & Edmonds, 1982: 138; Scholtz & Holm, 1985: 220; Krell, 1999: 288.

Sceliages iopas Westwood, 1837: 12. – Lacordaire, 1856: 66; Shipp, 1895: 38.

Sceliages jopas [Sic!] Westwood, 1837. – zur Strassen, 1965: 220, 228–230; Ferreira, 1972: 77.

Sceliages joppas [Sic!] Westwood, 1837. – Ferreira, 1972: 76.

Sceliages curvipes Gillet, 1911b: 310. – Gillet, 1911a: 16; zur Strassen, 1965: 228.

Material examined

Sceliages adamastor

Neotype. ♂, 'South Africa, WC, De Hoop Nature Res., 34°25'S 20°24'E, 2.xi.2000, millipede baited p/f trap, S. A. Forgie', SANC. (Here designated.)

Sceliages iopas

Holotype. ♀, 'South Africa; *Sceliages iopas* Westwood, 1837. Type coll.428', HECO.

Paratype. 1♂, 'South Africa; *Sceliages iopas* Westwood, 1837. Type coll.428', HECO.

Sceliages curvipes

Holotype. ♂, 'South Africa; *Sceliages curvipes* Gillet, 1911', BMNH.

Other material examined. 17 ♂ and 4 ♀. **South Africa, Western Cape Province:** De Hoop Nature Reserve (34°25'S 20°24'E), (1 ♂ UPSA); De Hoop Nature Reserve, nr Koppie Alleen, 34°28'S 20°28'E (2 ♂ SAMC); De Hoop Nature Reserve, Cape Agulhas, 60 km NE 34°25'S 20°24'E (2 ♂, 2 ♀ BMNH; 2 ♂, 1 ♀ SANC; 1 ♂, 1 ♀ UPSA); Klippe Rugt Farm, 34°42'S 20°12'E (1 ♂ TMSA). **Northern Cape:** Klipvlei, Garies, Namaqualand (30°25'S 17°54'E) (2♂ SAMC); Victoria West, 'Cape-Karoo', 31°24'S 23°07'E (4♂ TMSA). **Eastern Cape:** Papiessfontein, Gamtoos River Mouth (33°57'S 25°04'E) (3♂ SAMC). (?) **Orange Free State (Free State):** Modder River, Brandfont (1 ♂ SAMC).

Diagnosis

Sceliages adamastor possesses obtusely curved inward angulation of the mesotibiae. Presence of an obvious inward curvature of the metatibia is apparent in both males and females. The length of the outer mesotibial spur relative to the length of the mesotibia is markedly reduced. Setation generally black.

Redescription

Length 12–22 mm.

Head. Surface smooth to slightly rugose on genal epistomae. Genae and clypeus densely covered with large punctations. Geno-clypeal suture well defined.

Sternites. Surface of mesobasisternum coarsely shagreened with markedly spaced, shallow, feebly developed crescent-shaped punctations. Dorsal margins of punctations smooth. Setation generally absent.

Legs. Medial (inner) facet of protibia abruptly angled inwards from third (penultimate distal) external denticle (Figs 35, 36). Protibial width (in dorsal perspective) in distal quarter broadens markedly to apex. Mesotibia obtusely curved inwards, more rounded than rectilinear and truncate in apical third (Fig. 17). Inner mesotibial spur less than 1/2 length and thickness of outer mesotibial spur. Inner spur offset from outer spur by 15–20 degrees. Outer mesotibial spur 1/5 to 1/4 length of mesotibia (Fig. 17). Mesotarsi approximately half length of mesotibia. Mesofemora armed with many rows of dense long black setae on posterior facet (Fig. 51). Metatibia evenly curved inwards (Figs 21, 22).

Male genitalia (Fig. 11). Handle of virgular sclerite broad, steep semi-circular concavity along dorso-basal margin; evenly concave along entire ventral margin. Dorsal margin notched at terminus of union with circular sclerite prior to obvious swelling to terminus of apical region of handle. Secondary sclerotisation of handle reduced between dorsal and ventral corners of apex, forming slight saddle.

Geographical distribution

Sceliages adamastor is known only from South Africa (Fig. 84).

Remarks

Horn *et al.* (1990) provided no information regarding the Coleoptera collections of Le Peletier or Audinet-Serville. It therefore seems to be improbable that their locations, including the type(s) of *Ateuchus* (= *Sceliages*) *adamastor*, will ever be found. Moreover, Yves Cambefort (personal communication) of the Paris Museum of Natural History, home to portions of Le Peletier's collections, states the types described by both Le Peletier and Audinet-Serville are apparently unknown and are likely to be lost. In accordance with zur Strassen (1965) and those who have helped us in attempting to locate the type(s), *Sc. adamastor* type(s) are considered as missing or non-existent. We have therefore assigned a neotype for this species.

Redescription and identification of this species was therefore based on the descriptions of *Ateuchus adamastor* by Le Peletier de Saint-Fargeau and Serville (1828), examination of the conspecific types of *Sceliages iopas* and *Sc. curvipes*, the description of *Sc. iopas* by Westwood (1837), description of *Sc. adamastor* by zur Strassen (1965) and identified non-type material.

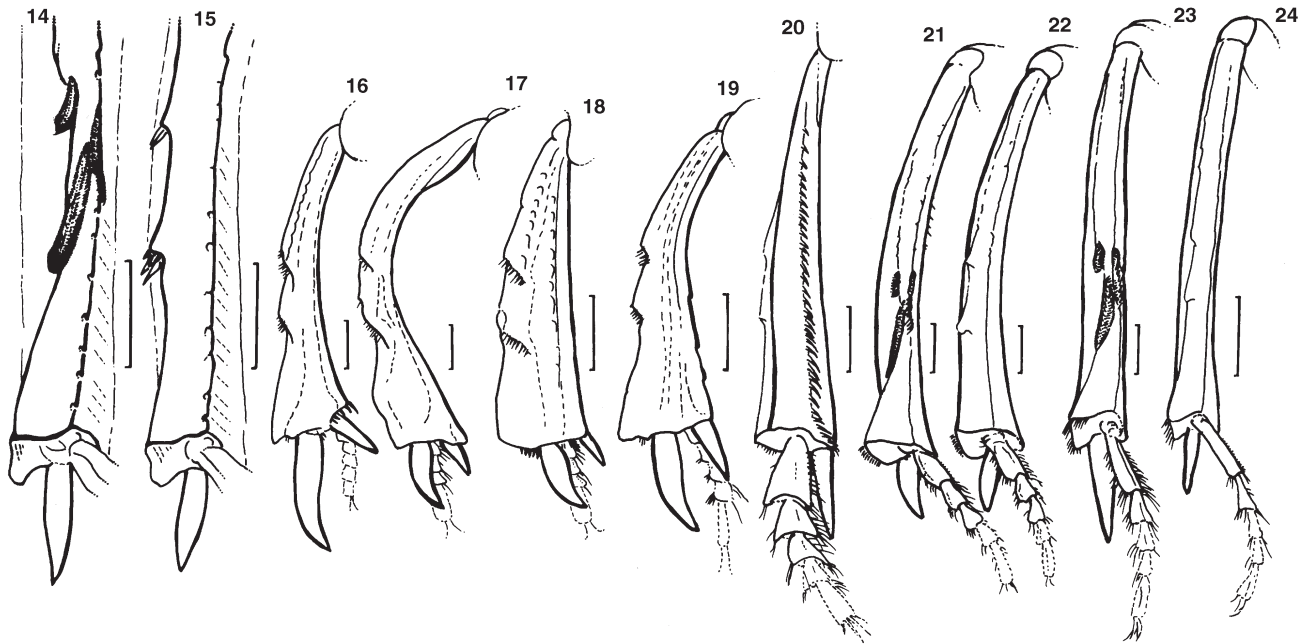

Figs 14–24. 14–15, Metatibia of *Sceliages*; sexual variation of distal apices (dorsal perspective), contours. Scale bars: 1 mm. 14, *Sceliages hippias*, ♂; 15, *Sc. hippias*, ♀. 16–19, Mesotibia and mesotibial spurs of *Sceliages* (dorsal perspective), contours. Scale bars: 1 mm. 16, *Sceliages brittoni*; 17, *Sc. adamastor*; 18, *Sc. hippias*; 19, *Sc. difficilis*. 20, Metatibia of *Sceliages gagates*; medial facet with medio-longitudinal setation/carina (dorso-lateral perspective), contour. Scale bar: 1 mm. 21–24, Metatibia of *Sceliages*; inward curvature (dorsal perspective), contours. Scale bars: 1 mm. 21, *Sceliages adamastor*, ♂; 22, *Sc. adamastor*, ♀; 23, *Sc. brittoni*, ♂; 24, *Sc. granulatus*, ♀.

It is worth noting the species labels of the two type specimens of *Sceliages iopas* held at the Hope Entomological Collections, University of Oxford, are hand written in a manner likely to be misinterpreted as *Sc. jopas*. The locality data of the Free State specimen is not considered accurate and is not included in the distribution map (Fig. 84). We also examined 12 specimens from the ISNB. Of these, two are misidentified specimens of *Sc. gagates* and two are misidentified specimens of *Sc. difficilis*. The remaining eight specimens of *Sc. adamastor* include minimal to no original collection data to be of any use in distribution maps.

The body size of *Sc. adamastor* is approximately as large as *Sc. brittoni* and smaller adult specimens may also be confused initially with large specimens of *Sc. difficilis*. The posterior surface of the mesofemora of *Sc. adamastor* specimens from De Hoop is armed with a single row of long black setae closely paralleling the ventral margin and a second, less dense, incomplete row inset from the posterior margin (Fig. 50). All other specimens of this species are heavily setose (Fig. 51). The mesotibia of males is only slightly more obtusely bowed and the inner facet of the protibia is more abruptly angled inwards than in females.

Sceliages augias Gillet

(Figs 4, 9, 31, 32, 48, 49, 81)

- Sceliages augias* Gillet, 1908: 64. – Felsche, 1910: 339; Gillet, 1911a: 16; Ferreira, 1961: 64; Ferreira, 1972: 67, 68; zur Strassen, 1965: 220; Mostert & Scholtz, 1986: 10.
Sceliages sulcipennis Felsche, 1910: 339. – Gillet, 1911a: 16.
 ? *Scarabaeus delaunay-larivierei* Paulian, 1934: 58. – Ferreira, 1961: 64.
Parascarabaeus tonkineus Balthasar, 1961: 174 (mislabelled specimen, Mostert and Scholtz 1986).

Material examined

Holotype. ♀, 'Angola, Benguela; F. C. Wallman Leg.', ISNB 10.640.

Other material examined. 2 ♂, 2 ♀. **Angola:** Casonda (7°23'S 20°54'E) (1 ♂ TMSA). **Democratic Republic of Congo:** Mukana (1 ♂ ISNB). **Zambia:** Abercorn (Mbala) (8°50'S 31°23'E) (1 ♂ ISNB); Algoa (Kabwe), Broken Hill, 180 km E (14°26'S 30°18'E) (1 ♂ BMNH); Mpika, Muchinga Mtns (11°42'S 27°10'E) (1 ♂ ISNB); Mweru-Wantipa (1 ♂ ISNB); Serenje District (1 ♂ BMNH); Serenje (13°10'S 30°47'E) (1 ♀ BMNH). **Tanzania:** Mpwapwa (6°21'S 36°29'E) (1 ♀ BMNH).

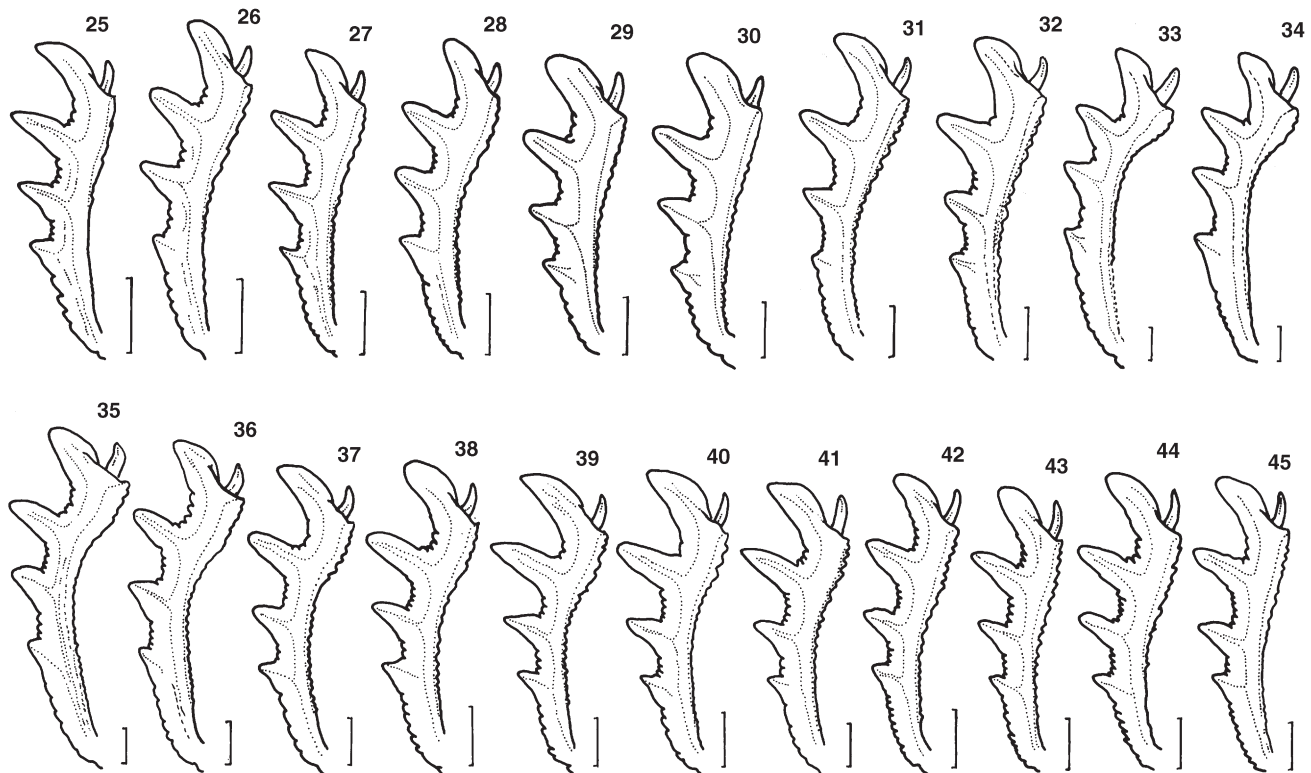

Figs 25–45. Protibiae of *Sceliages* (dorsal perspective), contours. Scale bars: 1 mm. 25, *Sceliages granulatus*, ♂ (Kimberley, RSA); 26, *Sc. granulatus*, ♀ (Kimberley, RSA); 27, *Sc. granulatus*, ♀ (Kang, Botswana); 28, *Sc. granulatus*, ♂ (Kang, Botswana); 29, *Sc. hippias*, ♂; 30, *Sc. hippias*, ♀; 31, *Sc. augias*, ♂; 32, *Sc. augias*, ♀; 33, *Sc. brittoni*, ♂; 34, *Sc. brittoni*, ♀; 35, *Sc. adamastor*, ♂; 36, *Sc. adamastor*, ♀; 37, *Sc. difficilis*, ♂ (Rhenosterpoort farm, RSA); 38, *Sc. difficilis*, ♀ (Rhenosterpoort farm, RSA); 39, *Sc. difficilis*, ♂ (Umtali, Zimbab.); 40, *Sc. difficilis*, ♀ (Umtali, Zimbab.); 41, *Sc. difficilis*, ♀ (holotype, BMNH); 42, *Sc. gagates*, ♂ (Muzi Area, RSA); 43, *Sc. gagates*, ♀ (Muzi Area, RSA); 44, *Sc. gagates*, ♂ (Delagoa B., Moçamb.); 45, *Sc. gagates*, ♀ (Delagoa B., Moçamb.).

Diagnosis

Sceliages augias is easily differentiated from the other species of *Sceliages* by the appearance of its elytra: pronounced longitudinal ridges/corrugations filled with a matt grey indumentum and the tops shiny black, providing a striped appearance.

Redescription

Length 10–18 mm.

Head. Surface rugosely punctated on genae and clypeus. Distal halves of geno-clypeal sutures obscured by rugose surface. Frons and vertex with less dense and smaller punctations.

Pronotum. Obtusely rounded with curvature in the posterior third of lateral margins. Thickness and angulation of lateral margins unvaried.

Elytra. Pronounced longitudinal carina or corrugations positioned medially on surface between each stria. Surface texture coarsely shagreened. Surfaces between carinae covered with indumentum and appearing matt grey. Carinae shiny black without waxy indumentum. Elytra appearing striped or ribbed.

Sternites. Surface of mesobasisternum coarsely shagreened with well-spaced, crescent-shaped, faceted punctations. Punctations raised forming protrusions or turbercle-like structures. Dorsal margins of protrusions smooth. Protrusions each armed with single long seta.

Legs. Spur-like projection markedly pronounced on anterior ventral ridges of both profemora and protrochanter (Fig. 4). Inner face of protibia slightly angled inwards from second external protibial denticle (Figs 31, 32). Mesofemora armed with few (Fig. 49) to many (Fig. 48) rows of long setae on the posterior facet. Inner mesotibial spur 2/3 length of outer spur and 1/2 its thickness; angle is offset from outer spur by 30 degrees. Mesotarsus between 1/2 and 2/3 length of mesotibia.

Male genitalia (Fig. 9). Handle of virgular sclerite broad in width, steeply concave along dorsal margin of basal region and evenly concave along ventral margin. Dorsal margin notched immediately after distal terminus of union with circular sclerite. Dorsal margin angles abruptly upwards to apex of handle. Apical region tapers to its widest thickness at apex. Apex angulate and width nearly as broad as length of dorsal margin from apex to notch. Secondary sclerotisation

of handle reduced in ventral corner of apical region and dorsal corner of basal region. Handle has small baso-ventral extension also with reduction in secondary sclerotisation.

Geographical distribution

We saw specimens of *Sc. augias* from the Dominican Republic of Congo, Angola, Zambia and a single specimen labelled 'Mpwapwa' with no other collection information provided. The only locality fitting this name occurs in far eastern Tanzania. If this locality is correct, the distribution of the species is extended all the way across central Africa. Its distribution point however has not been included in Fig. 82. A further record cited by zur Strassen (1965: 221) from the Upemba National Park, DRC, is incorporated in Fig. 82.

Remarks

We are not aware who formally synonymised *Scarabaeus delaunay-larivierei* with *Sc. augias*; we follow Ferreira (1961: 64), who is the first author known to us to use this synonymy.

Intra-specific variation in the degree of setation or pubescence on the mesofemoral posterior surface is apparent among specimens of *Sc. augias*. Specimens from coastal Casonda, Angola possess dense setation similar to that of *Sc. brittoni* (Fig. 48) compared with inland specimens (e.g. Fig. 49).

Sceliages brittoni zur Strassen

(Figs 5, 10, 16, 23, 33, 34, 48, 83)

Sceliages brittoni zur Strassen, 1965: 230. – Ferreira, 1972: 77.

Material examined

Holotype. ♂, 'South Africa: SW Cape (Western Cape Province); Leipoldville, Eland's Bay (32°13'S 18°29'E); October 1947, museum exped.', SAMC.

Paratypes. 1 ♀, 'South Africa: SW Cape (Western Cape Province); Darling (33°23'S 18°23'E); October 1906, L.Péringuey', SAMC; 1 ♀, 'Eland's Bay; October 1947, museum exped.', SAMC; 1 ♀, 'Saldanha Bay (33°03'S 18°00'E); September 1960 'S.A.M.', SAMC.

Other material examined. **South Africa, Western Cape Prov.:** Namaqualand Kommandokraal farm, 31°30'S 18°13'E (1 ♂ TMSA); Langebaan, Geelbek, 12 km SE (33°06'S 18°02'E) (3 ♂, 2 ♀ SANC); Langebaan, Geelbek, 12 km SE (1 ♂ SANC), Nortier farm, 32°02'S 18°20'E (1 ♂ TMSA); Seweputs coast, 31°39'S 18°17'E (1 ♂ TMSA). **Northern Cape Prov.:** Hondeklipbaai, 30°19'S 17°16'E; (1 ♀ SANC); Hondeklipbaai, 12 km E, 30°21'S 17°25'E (11 ♂, 4 ♀ TMSA); Kotzesrus, 30°57'S 17°50'E (2 ♂ TMSA); Quaggafontein, 30°13'S 17°33'E (1 ♂ TMSA); Vlake farm, Gembok, 30°30'S 17°29'E (2 ♂ TMSA).

Diagnosis

Sceliages brittoni is easily diagnosed with the following morphological characters: red setation; markedly elongate outer mesotibial spur relative to the length of the mesotibia;

and a large body size. The distribution of *Sc. brittoni* is restricted to the west coastal regions of South Africa.

Redescription

Length 17–25 mm.

Sternites. Surface of mesobasisternum texture coarsely shagreened. Punctations crescent-shaped and faceted. Punctations raised forming protrusion or turbercle-like structures; dense but generally unlinked radiating anterior-laterally from centre of mesosternal process. Setation generally absent.

Legs. Medial (inner) facet of protibia abruptly angled inwards from third external denticle (Figs 33, 34). Protibial width (in dorsal perspective) in distal quarter broadens abruptly to apex. Profemoral spur-like projection pronounced with reduced tooth-like serrations on remainder of anterior ventral ridge of both profemora and protrochanter (Fig. 5). Spur-like projection may be present but reduced on anterior ventral ridge of protrochanter. Mesofemora armed with many rows of dense, obvious long red/brown setae on the posterior facet (Fig. 48). Outer mesotibial spur markedly elongate; approximately half length of mesotibia (Fig. 16). Inner mesotibial spur less than 1/3 length and width of outer spur; offset from outer spur by 30 to 45 degrees. Mesotarsus approximately 1/3 length of mesotibia. Minimal to no inward curvature of metatibia (Fig. 23).

Male genitalia (Fig. 10). Handle of virgular sclerite narrow and relatively constant thickness through its length; widening slightly at each end. Handle evenly concave along majority of dorsal margin to an abrupt outward angulation near terminus of apical region; ventral margin slightly concave to angulate. Dorsal margin unnotched at terminus of union with circular sclerite. Secondary sclerotisation of handle reduced between dorsal and ventral corners of apex forming an obvious saddle. Dorsal and ventral corners of apical region of handle appear as protruding points. Baso-ventral corner forms a slight protruding extension with reduction in secondary sclerotisation from its apex to baso-dorsal union with circular sclerite.

Biological observations

A single specimen of *Sceliages brittoni* in Namaqualand, South Africa, was observed displacing reduviid nymphs (species unknown) that were attacking a large harpagophorid millipede, *Zinophora* sp. (Diplopoda : Spirostreptida). *Sceliages brittoni* then relocated the millipede while it was still alive (J. Colville, personal communication).

Geographical distribution

Sceliages brittoni is known from South Africa only (Fig. 84).

Remarks

The majority of the external morphological features of *Sc. brittoni* closely resemble those of *Sc. adamastor*.

Sceliages difficilis zur Strassen

(Figs 12, 19, 37–41, 52, 53, 82)

Sceliages difficilis zur Strassen, 1965: 224. – Ferreira, 1972: 77.*Material examined*

Holotype. ♀, 'South Africa: Eastern Cape Province; Grahamstown; ex. coll. Fry 1905–100', BMNH.

Paratypes. 1 ♂ and 1 ♀, 'South Africa: Natal (Kwazulu-Natal); Krantzkop (Kranskop) (28°58'S 30°51'E); November 1917, K.H. Barnard', SAMC. 1 ♂, 'Natal (Kwazulu-Natal); pt. '58.13'', BMNH; 1 ♂, 'Natal (Kwazulu-Natal); ex. coll. Pascoe', BMNH; 1 ♂, 'Natal (Kwazulu-Natal), Durban; A.E. Miller', SAMC; 1 ♂, 'Zimbabwe: Salisbury (Harare), Mashunaland (17°50'S 31°03'E); 1893, G.A. Marshall', SAMC; 1 ♂, 'Nyanyadzi R. (Nyanyadzi), Gazaland (19°45'S 32°25'E); November 1901, G.A.K. Marshall', BMNH; 1 ♂, 'Africa, austr.; Coll. J.J. Gillet', ISNB.

Other material examined. **South Africa, Gauteng:** Boekenhoutskloof, Pretoria, 30 km NE (25°31'S 28°25'E) (6 ♂, 3 ♀ SANC); Johannesburg (26°12'S 28°05'E) (1 ♂, 1 ♀ TMSA); Rhenosterpoort Farm, 25°43'S 28°56'E (2 ♂, 2 ♀ TMSA); Valhalla, Pretoria (25°49'S 28°08'E) (1 ♀ TMSA); Mpumalanga, Groenvaly farm, nr Badplaas, 50 km N (25°50'S 30°45'E) (3 ♂, 1 ♀ UPSA); Lydenburg District, Kopies Kraal, 25°06'S 30°12'E (2 ♂ TMSA). **Northern Province:** Motlakeng, Blouberg (23°05'S 29°01'E) (1 ♀ TMSA); Nylsvley Nature Reserve, 24°39'S 28°42'E (1 ♂ UPSA); Nylsvley, Smith Farm, 24°40'S 28°42'E (1 ♂ TMSA); Pietersburg (23°50'S 29°20'E) (1 ♂ TMSA); Sand River, Thabazimbi 24°32'S 27°39'E (1 ♀ UPSA); Iron Crown, 2 km W, Wolkberge, Haenertsberg Distr. (24°00'S 29°57'E) (1 ♀ TMSA). **Kwazulu-Natal:** 'ZuluLand' (1 ♂ BMNH; *Sceliages iopas* W.); 'Natal' (1 ♂ BMNH); (Free State), Glen (1 ♀ SANC). **Zimbabwe:** Harare, Mashunaland[sic] (1 ♂ BMNH); Peak Mine, Selukwe (Shurugwi) (19°40'S 30°00'E) (1 ♀ SAMC); Chipinga (Chipinge) (20°12'S 32°37'E) (1 ♂ TMSA); Upper Búzi River (19°51'S 32°48'E) (1 ♀ BMNH 1908-212); Upper Búzi River, Gazaland (Melssetter Distr) (1 ♂ BMNH 1931-138); Mt Chirinda, 'Gaza Ld.' (19°14'S 32°14'E) (1 ♀ BMNH); Mt Chirinda, Gazaland (1 ♂ BMNH; 1931–138); Chirinda Forest (1 ♀ TMSA); Umtali (Mutare) (18°58'S 32°40'E), (1 ♂ SAMC; specimen v. poor cond.); Umtali (Mutare), Mashonaland (3 ♂, 1 ♀ BMNH 1904-206); 'Rhodésie', Plumtree, Rhodesia (1 ♂ ISNB; *Sc. adamastor* 10.640); 'Rhodésie', Salisbury (Harare), Mashonaland (1 ♀ ISNB; *Sc. adamastor*).

Diagnosis

Sceliages difficilis can be diagnosed using the angulation of the protibiae (the medial facet of the protibia is slightly angled inwards from between the third external denticle to half-way to the second external denticle; protibial width is even from the base to parallel with the third external denticle where the width broadens slightly to the apex), and the protruding extension of the baso-ventral corner of the virgular sclerite handle.

Redescription

Length 10–18 mm.

Pronotum. Lateral margins evenly rounded, narrow and even.

Elytra. Surface smooth with flat to slightly raised, minute granulations (more apparent in teneral adults). Stria

markedly developed (more apparent in teneral adults) comprising a longitudinal pair of microcarina. Minimal to no longitudinal groove bordered by microcarinae.

Sternites. Surface of mesobasisternum coarsely shagreened, large crescent-shaped punctations, densely arranged and often linked, radiating anterior-laterally from centre of mesosternal process. Punctations generally armed with single very short brown/black setae.

Legs. Medial facet of protibia slightly angled inwards from between third external denticle to half-way to second external denticle (Figs 37–41). Even protibial width from base to parallel with third external denticle, where broadens slightly to apex. Protibial angulation and start of angulation more subtle in females (Figs 38, 40, 41). Mesofemora armed with three (Fig. 53) to four (Fig. 52) rows of long thick black/brown setae on posterior facet. Most rows approximately equal in length. Second row from ventral marginal row often reduced setation. Mesotibia slightly curved inwards (Fig. 19). Outer mesotibial spur 1/3 length of mesotibia. Inner spur 2/3 length and 1/3 width of outer spur. Inner mesotibial spur offset from the outer spur by 10 to 20 degrees. Mesotarsus 2/3 length of mesotibia.

Male genitalia (Fig. 12). Handle of virgular sclerite of relatively constant thickness through most its length, widening slightly at each end. Handle evenly concave along majority of dorsal and ventral margin. Dorsal margin unnotched at terminus of union with circular sclerite. Apical margin of handle rectangular. Basal margin between dorsal and ventral corners slightly concave. Secondary sclerotisation of handle reduced in apical ventral corner and apical dorsal corner. Baso-ventral corner forms protruding extension with reduction in secondary sclerotisation.

Geographical distribution

Sceliages difficilis is known from South Africa and Zimbabwe (Fig. 83).

Remarks

The etymology of the species name *difficilis* could be based on the difficulty to accurately diagnose this species. *Sceliages difficilis* closely resembles *Sc. gagates* and *Sc. adamastor*. Geographic distribution (*Sc. gagates* is restricted to the eastern coastal regions), differences in width curvature/angulation of the protibiae and pronotum lateral margins (more evenly rounded in *Sc. difficilis* and more obtusely rounded/flared in *Sc. gagates*) are the principal characters for separating the two species. Some specimens of *Sc. difficilis* have been misidentified as *Sc. adamastor*. This may be due to the curvature of mesotibia reminiscent of this strong diagnostic feature in *Sc. adamastor* (Fig. 17). Note, however, on *Sc. adamastor*, the outer mesotibial spur is markedly shorter than the length of mesotibia (Fig. 17) compared with *Sc. difficilis* (Fig. 19) and the mesotarsi of

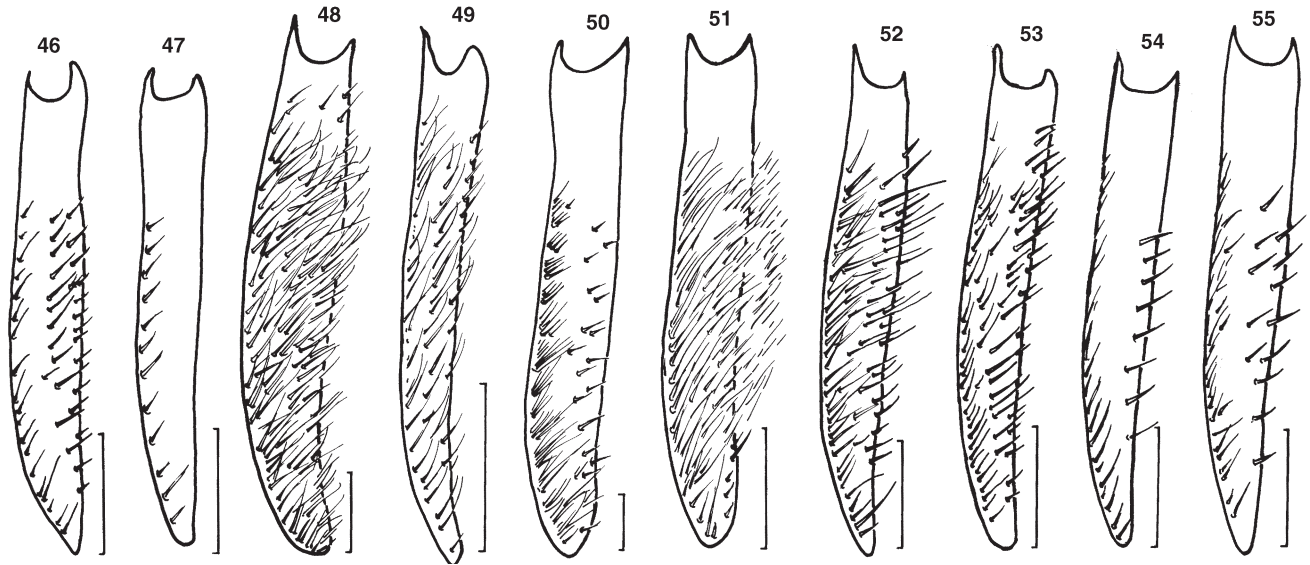

Figs 46–55. Mesofemora of *Sceliages*; setation/pubescence on posterior facet. Left margins are dorsal (lateral perspective). Scale bars: 1 mm. 46, *Sceliages granulatus*; 47, *Sc. hippias*; 48, *Sc. brittoni* and *Sc. augias* (Casonda, Angola); 49, *Sc. augias* (Mpwapura); 50, *Sc. adamastor* (De Hoop Nat. Res., RSA); 51, *Sc. adamastor*; 52, *Sc. difficilis* (Badplaas, RSA); 53, *Sc. difficilis* (Boekenhoutskloof, RSA); 54, *Sc. gagates* (Muzi Area, RSA); 55, *Sc. gagates* (Muzi Area, RSA).

Sc. difficilis are 2/3 the length of the mesotibiae (cf. mesotarsi of *Sc. adamastor* are 1/2 the length of the mesotibiae).

Sceliages gagates Shipp

(Figs 13, 20, 42–45, 54, 55, 82)

Sceliages gagates Shipp, 1895: 38. – Gillet, 1911a: 16; Ferreira, 1961: 64; Ferreira, 1967: 60; Ferreira, 1972: 78; zur Strassen, 1965: 226–229.

Material examined

Neotype. ♂, 'Sordwana Bay, Natal (3 km from camp); 15.x.1978, Bornemissza & Aschenborn', SANC, database No: COLS 00045. (Here designated.)

Other material examined. **South Africa, Kwazulu-Natal:** Kozu Bay (26°52'S 32°50'E) (1 ♂ UPSA); Muzi, Tongaland (Ingwavuma Distr.) 26°52'S 32°29'E (2 ♂, 1 ♀ SANC); Muzi Area (Ubombo Distr.) 'N. Natal' (27°29'S 32°23'E) (5 ♂, 2 ♀ SANC); Sodwana Bay (27°32'S 32°41'E) (2 ♂ SANC); St Lucia Estuary (28°21'S 32°29'E) (1 ♂, 1 ♀ SANC); Tembe Elephant Pk, 'N. Kwazulu Natal' 26°51'S 32°24'E (1 ♀ UPSA). **North-west Province:** (?) Sand R. Mtn, 24°32'S 27°39'E (1 ♀ UPSA). **Moçambique:** Delagoa Bay (Maputo, Baía de) (25°48'S 32°51'E) (6 ♂, 6 ♀ BMNH); 'Delagoa' (1 ♂ BMNH; 3 ♂ ISNB); 'Dela. B., Mozamb.' (1 ♂ BMNH); Inhambane (23°52'S 35°23'E) (1 ♀ SAMC); Lourenço Marques (Maputo) (2 ♂ SAMC); Nyaka, 'P E. Afr.' (30°9'S 29°46'E) (1 ♂ SAMC).

Diagnosis

Diagnostic morphological characters that distinguish *Sc. gagates* from *Sc. difficilis* are: the lateral margins of the pronotum (obtusely rounded; lateral margins flared medially and narrow posteriorly; dorsal edge of margin upturned

slightly); and the differences in protibia angulation (medial facet of protibia slightly angled inwards from second protibial denticle; even and slight increase of protibial width from base to apex). The distribution of *Sc. gagates* is restricted to the coastal regions of north-eastern South Africa and Moçambique and is regarded as a key diagnostic character for the species.

Redescription

Length 10–18 mm.

Pronotum. Lateral margins obtusely rounded, flared medially and narrow posteriorly. Dorsal edge of margin upturned slightly.

Elytra. Surface smooth with flat, minute granulations (more apparent in teneral adults). Stria comprising a groove without longitudinal microcarina bordering either side.

Sternites. Surface of mesobasisternum with pronounced crescent-shaped, posteriorly faceted punctations. Punctations raised forming protrusion or turbercle-like structures; dense but generally unlinked, radiating antero-laterally from centre of mesosternal process. Each punctation armed with a single red-brown seta.

Legs. Medial facet of protibia slightly angled inwards from second protibial denticle (Figs 42–45). Even and slight increase of protibial width (in dorsal perspective) from base to apex. Mesofemora armed with two (Fig. 54) to three (Fig. 55) rows of red/brown setae on posterior facet. First row dense and mostly uniform on postero-ventral margin. Second row with setation well spaced and reduced in number from first row. Third row further reduced to absent. Outer

mesotibial spur 1/3 length of mesotibia. Inner spur 2/3 length and 1/3 width of outer spur. Inner mesotibial spur offset from outer spur by 20 to 30 degrees. Mesotibia slightly curved inwards. Mesotarsi greater than 2/3 length of mesotibia.

Male genitalia (Fig. 13). Handle of virgular sclerite relatively thin medially widening at each end. Handle evenly concave along dorsal margin of medio-basal region of handle and majority of ventral margin. Dorsal margin extended horizontally outward from terminus of distal union with circular sclerite prior to upward angulation to apex. Apical margin of handle roughly triangular. Basal margin between dorsal and ventral corners straight. Secondary sclerotisation of handle heavily reduced in apical ventral corner and extending baso-ventrally in apical region. Baso-ventral corner forms a pronounced downward protruding extension with reduction in secondary sclerotisation throughout and extending to baso-dorsal union with circular sclerite.

Geographical distribution

Sceliages gagates is known from the lowland coastal regions of north-eastern South Africa and southern Moçambique (Fig. 83).

Remarks

Type specimens could not be located for this revision, nor could their existence be confirmed (Horn *et al.* 1990). Only a few types from the original Shipp collection were retained by the Hope Entomological Collections, Oxford University Museum of Natural History. Some of the collection was purchased by P. M. Bright, but that part contains no scarabaeines (D. Mann, personal communication). The location of the location of most of Shipp's types remains a mystery. According to zur Strassen (1965), a [holo]type of *Sc. gagates* with the locality 'limpopo' was apparently lodged with the BMNH. All specimens of *Sceliages* were loaned from the BMNH for this revision and no types of *Sc. gagates* were present. Zur Strassen (1965) was met with the same circumstances and also questioned the existence of types, most especially, the supposed type specimen. Zur Strassen (1965) also argued that the original description by Shipp was inaccurate and could easily have been based on a specimen of *Sc. hippias* lacking its yellow apical antennomeres, or *Sc. difficilis*, an undescribed species in 1895.

With an absence of types, our description of this species was initially based on the original description by Shipp (1895) and, in accordance with zur Strassen (1965), found Shipp's description more akin to that of *Sc. difficilis*. We therefore relied on the description and key by zur Strassen (1965) and examination of as many specimens we could obtain. We noticed an obvious lack in zur Strassen's work of the geographic localities of the specimens he examined and subsequently identified either as *Sc. gagates* or *Sc. difficilis*, which made their differentiation rather ambiguous. This led us to redescribe the species based on lowland coastal

specimens of *Sc. gagates* or mislabelled *Sc. difficilis*, which possess uniformity in the morphological characters we regard as descriptive for *Sc. gagates*.

Based on the current redescription of *Sc. gagates* the [holo]type with the locality 'limpopo' is likely to be correct only if the specimen was collected in the eastern lowland coastal region of Moçambique through which the Limpopo River flows. However, its location, or that of any other type for this species, remains a mystery. General agreement by those who have helped us try to locate missing types is that they should be treated as non-existent and neotypes should be assigned. This we have done.

Subtle intra-specific variations or external wear on diagnostic characters of both *Sc. gagates* and *Sc. difficilis* can easily lead to misidentification for either species. There are relatively few consistently sound diagnostic characters that could be described to separate the two species. Ambiguous male specimens of *Sc. gagates* that could be misidentified as *Sc. difficilis* do, however, show reasonably consistent similarities in their virgular sclerites.

***Sceliages granulatus* Forgie & Scholtz, sp. nov.**

(Figs 1, 6, 7, 24, 25–28, 46, 80)

Material examined

Holotype. ♂, 'Botswana: Kang, 35 km SE, millipede-baited pitfall trap; 23 January 1978, A.L.V. Davis' (23°46'S 22°51'E), SANC. **Paratypes.** 3 ♂, 1 ♀, same data as holotype, SANC; 1 ♂, 2 ♀, 'Botswana: Sekoma, 26 km E, millipede-baited pitfall trap, 24–25 January 1978, A.L.V. Davis' (24°24'S 23°53'), 1 ♂ in UPSA, 2 ♀ in SANC.

Other material examined. **South Africa:** 1 ♂, 'Northern Cape Province; Olifantshoek, 45 km SW, 28 February 1973, Bornemissza and Temby' (27°56'S 22°44'), SANC; 1 ♀, 'Vryburg' (26°57'S 24°44'), SAMC; 2 ♂, 1 ♀, 'South Africa: 'Cape Province', Kimberley 28°44'S 24°46', October–November, 1980, S. Erasmus', SANC.

Diagnosis

Sceliages granulatus shares a similar overall appearance with small teneral adults of *Sc. difficilis* except for the following differences present in *Sc. granulatus*: an obvious indumentum covering the elytra; granulations on elytra more obvious and pronounced; striae on the elytra are more pronounced; pronotum lateral margins are obtusely rounded (similar to *Sc. gagates*).

Description

Length 11–13 mm.

Head. Surface rugose, densely punctated on genae and clypeus. Punctations on marginal regions of clypeus and gena form prolonged ripple-like ridges. Geno-clypeal suture obscured along apical half by punctations and roughness of surface near geno-clypeal margins. Antennae armed with dense array of pale minute sensilla on apical margins and dorsal surfaces on antennal club antennomeres.

Pronotum. Surface coarsely shagreened, covered in minute punctations and fine, flat granulations. Lateral margins of pronotum obtusely rounded. Width of pronotal lateral margins constant in posterior half. Angulation of lateral margin without variation posteriorly and minimal to none medially. Entire dorsal lateral margin well defined.

Elytra. Surface coarsely shagreened, covered in well developed granulations. Stria bordered with 2 evenly spaced carinae; granulation absent in strips running parallel with outer margins of each carina. Elytra covered with thin layer of indumentum providing dull matt appearance.

Sternites. Surface of mesobasisternum finely shagreened, covered with large punctations often linked in ripple-like chains of four or more. Punctations crescent-shaped and slightly facetted. Facets between inner margins of mesocoxal cavities and lateral carinae of mesosternellum undermined posteriorly and straightened to vertical at deepest point. Each facet outwardly curved twisting to horizontal anteriorly. Carina curved at union with mesobasisternal–mesepisternal suture.

Legs. Medial (inner) facet of protibia poorly curved inwards. In females, curvature even (Figs 26, 27). In males, curvature subtly more apparent from second external protibial denticle (Figs 25, 28). Medial facet of protibia twisted by 45 degrees from vertical in proximal half to horizontal position in distal half. In males, medial carina of keel of first (most basal) protibial denticle reaches dorsal longitudinal carina. Antero-ventral margin of profemora adjacent to protrochanter armed with one spur-like projection. Posterior facet of mesofemora armed with three rows of setae running parallel to dorsal and ventral margins (Fig. 46). Rows of variable length. Setae of variable density. Vagrant setae located sparsely between rows. Mesotibiae poorly curved inwards. Outer mesotibial spur approximately 1/3 length of mesotibia. Inner mesotibial spur more than 2/3 length of outer spur. Inner mesotibial spur offset from outer spur by 15 degrees. Mesotarsus approximately 2/3 length of mesotibia. Metatibia (in dorsal perspective) without inward curvature (Fig. 24).

Male genitalia (Figs 6, 7). Handle of virgular sclerite broadly concave along medial region; dorsal margins steeply curved upwards at both ends. Apical region tapers to its widest at apex. Apex rounded at dorsal corner; angled at ventral corner. Secondary sclerotisation reduced transversely in ventral corner of apex of handle. Basal region of handle has reduction of secondary sclerotisation at dorsal corner. Baso-ventral corner of handle has pronounced rectangulate extension.

Geographical distribution

Sceliages granulatus is known from semi-arid regions of southern Botswana and the northern part of central South Africa (Fig. 81) in areas considered to represent Kalahari sands.

Remarks

The virgular sclerite of *Sc. granulatus* from Kimberley (Fig. 7) differs slightly from the Botswana specimens (Fig. 6) in possessing a slightly thinner, less tapered apical region without angulation at the apex. Generally, virgular sclerites show little to no intraspecific variation and are therefore regarded as species specific and highly conserved. Only two male specimens have been collected from Kimberley, which prevents testing whether or not these differences are consistent. Although no external differences are apparent between the South African and Botswana specimens, the former have not been included in the type series.

Specific epithet

The species name is derived from the small but pronounced granulations on the elytra.

Sceliages hippias Westwood

(Figs 3, 8, 14, 15, 18, 29, 30, 47, 56–79, 80)

Sceliages hippias Westwood, 1844: 100. – Shipp, 1895: 39; Péringuey, 1901: 64; Gillet, 1911a: 16; Ferreira, 1961: 65; Ferreira, 1972: 78; zur Strassen, 1965: 221, 222, 224, 226–228. *Ateuchus microcephalus* Boheman, 1857: 176. – Shipp, 1895: 38.

Material examined

Holotype. ♂, ‘?type’ ‘Int. S. Afr.’, BMNH 54-76.

Other material examined. **South Africa:** ‘Cap’ (1 ♂ ISNB). **Mpumalanga:** Watervalriverpass, 24°54’S 30°21’E (1 ♀ TMSA); Lydenburg, Waterval Pass, 11 km NE (1 ♂ TMSA); Lydenberg District (1 ♂, 1 ♀ SAMC); Schmoemansville (25°01’S 30°31’E) (1 ♀ TMSA). **Kwazulu-Natal:** ‘Burn’ (1 ♂ SAMC); Tugela Ferry (28°44’S 30°27’E) (1 ♀ TMSA); Weenen (28°51’S 30°04’E) (2 ♂ BMNH); Tugela R., Weenen (1 ♂, 1 ♀ DMSA). **Northern Province:** Blouberg (23°05’S 29°01’) (1 ♂ TMSA); Blouberg, 23°05’S 29°01’ (1 ♂ SANC); Nylstroom 24°40’S 28°15’E (1 ♀ UPSA); Nylsvlei, Smith Farm 24°40’S 28°42’E (1 ♂ TMSA); Pietersburg, 24°14’40’’S 29°15’30’’E (1 ♂, 2 ♀ UPSA); Rhenosterpoort Farm (24°45’S 28°23’E) (2 ♀ TMSA); Vic. Mmafete 24°11’S 30°06’E (1 ♂ UPSA); Warmbad (24°50’S 28°20’E) (1 ♂ UPSA). **North-west Province:** Rustenberg Nature Reserve 25°40’S 27°12’E (1 ♂, 1 ♀ SANC; 1 ♂, 8 ♀ UPSA); Tonguani Gorge, Pretoria, 81 km W (25°50’S 27°30’E) (1 ♂ SANC); Retiefskloof, Rustenberg, 15 km SE (25°49’S 27°16’E) (1 ♀ SANC); Thambazimbi, 30 km W, SE (24°35’S 27°20’E) (1 ♂ UPSA). **Gauteng:** Johannesburg (26°12’S 28°05’E) (3 ♂ TMSA; 1 ♂ SAMC); Kameeldrift, Pretoria, 24 km NE (25°39’S 28°21’E) (1 ♂ SANC); ‘nr Johannesburg’ (1 ♂ BMNH 1906-29); Roodeplaat Farm, Pretoria, 20 km NE (25°34’S 28°22’E) (1 ♀ SANC); Hennopsriver, Pretoria, 32 km W (25°50’S 27°58’E) (1 ♂ SANC); Pretoria (3 ♂ SANC; 1 ♂ SAMC; 1 ♂, 1 ♀ UPSA); Swartkops, nr Jhb (26°05’S 27°45’E) (1 ♂ BMNH); Welgedacht, Pretoria, 50 km N (25°20’S 28°20’E) (1 ♂ UPSA).

Diagnosis

Sceliages hippias is easily identifiable with the yellow/orange colour of the antennomeres, especially in live specimens. Should this character be ambiguous or missing in dead pinned specimens, then correct diagnosis of the species

is assured with the unique setation on the posterior facet of the mesofemora and mesotibiae are relatively short, evenly tapering to the distal apex and without any curvature.

Redescription

Length 12–16 mm.

Head. Surface of frons and vertex smooth with smaller, fewer punctations than in geno-clypeal region. Geno-clypeal suture is obscured by dense punctations and rough surface along its apical half. Antennal club yellow~orange.

Pronotum. Lateral margins of pronotum obtusely rounded. Angulation of lateral margins of pronotum unvaried. Lateral margins of even width in posterior half.

Elytra. Surface smooth, finely punctated and without waxy indumentum. Striae faint, lineal grooves infrequently bordered by minute carinae, and interrupted by punctations.

Sternites. Surface of mesobasisternum smooth with large, evenly spaced, scalloped punctations radiating in vague linear fashion, antero-laterally from centre of mesosternal process. Mesosternum loosely covered in minute punctations, most armed with a single minute pale seta.

Legs. Medial facet of protibia angled slightly, if at all, inwards from second protibial denticle (Figs 29, 30). Protibia width increasing evenly and slightly from base to apex. Antero-ventral margin of profemora adjacent to trochanter an obvious ridge, rounded, without serration; spur-like projection absent (Fig. 3). Mesofemora armed with single row of setae closely paralleling ventral margin in basal half of posterior facet (Fig. 47). Inner facet of mesotibia straight (Fig. 18). Outer mesotibial spur approximately 1/4 length of mesotibia. Inner mesotibial spur equal in length to outer spur and 1/2 its thickness. Angle of inner mesotibial spur is generally offset from outer spur by 10 degrees. Mesotarsus approximately 2/3 length of mesotibia.

Male genitalia (Fig. 8). Handle of virgular sclerite thin in width, unevenly concave along baso-dorsal and ventral margins, and of relatively constant thickness. Dorsal margin angle down or notched at distal terminus of union with circular sclerite. Apical region of handle abruptly curved upward giving handle an overall sickle-shape appearance. Apical region is slightly thicker than basal region and rectilinear at its apex. Both dorsal and ventral corners of apex have approximately equal reduction in secondary sclerotisation.

Geographical distribution

Sceliages hippias is known only from the north-eastern corner of South Africa (Fig. 81).

Remarks

Much of the Westwood collection, including many of the types, was housed in the Zoological Society of London's collection, which was later incorporated into the main series collections of the BMNH before 1900. According to

D. Mann (personal communication), the Westwood type of *Sceliages hippias*, if extant, would have been in the series we received from the BMNH for this revision. D. Mann warned that the specimen (if present) may not be labelled as a Westwood species, as the labelling of that period was scant to say the least. We examined a specimen labelled '?type' and 'Int. S. Afr.' from the BMNH series with an accession number, 54-76. The type label may well have been added by zur Strassen during his revision of the genus in which he states this specimen, along with the female *Ateuchus microcephalus* paratype labelled 'Caffraria' in The Natural History Museum of Stockholm, are dubious. Zur Strassen (1965) concluded in his discussion of *Sc. hippias* that it is likely that the holotype and paratype(s) are lost and should be regarded as non-existent. However, further examination of the BMNH '?type' specimen labels, and cross referencing of the museum accession number with the accessions registrar in the entomology library of the BMNH, reveals this specimen to be the actual holotype for *Sceliages hippias*. The specimen in question has subsequently been correctly labelled as the holotype by D. Mann and remains housed in the BMNH.

Redescription and identification of this species was therefore based on the descriptions by Westwood (1844) and zur Strassen (1965), identified material and a diagnostic key of the genus by zur Strassen (1965).

NB. If some or all of the setae on the posterior facet of the mesofemora are absent, then the setal sockets should be evident enough to identify this species.

Description of mature larvae of *Sceliages hippias*

Diagnosis

The appearance of mature *Sc. hippias* larvae is typical of those of the subfamily Scarabaeinae (Edmonds and Halfiter 1978). They differ, however, from other larvae of the subfamily in possessing the following unique (*) or rarely found characters: (1*) tormae and epitormae are markedly reduced, close to absent; (2) dorsal surface of the stipes is without an irregular row of conical (= 'stridulatory') teeth along the basal margin; (3*) hypopharyngeal area is without two dissimilar sclerites (oncyli); (4) antennae with three segments; (5) venter of the last abdominal segment lacks any rows or patches of short setae; and (6) raster absent.

Description

Body-shape typical for Scarabaeinae larvae: whitish body strongly bent at about middle with markedly developed secondary dorsal folds. Head capsule (Figs 58–61): width *c.* 3.0 mm. Each hypostomal ridge is subdivided into two short sub-elements. Epipharynx (Fig. 57): tormae markedly reduced and nearly absent. Antenna (Figs 71, 72): three segments; basal segment with five pores and no setae; middle segment with flat sensorium, two pores and four

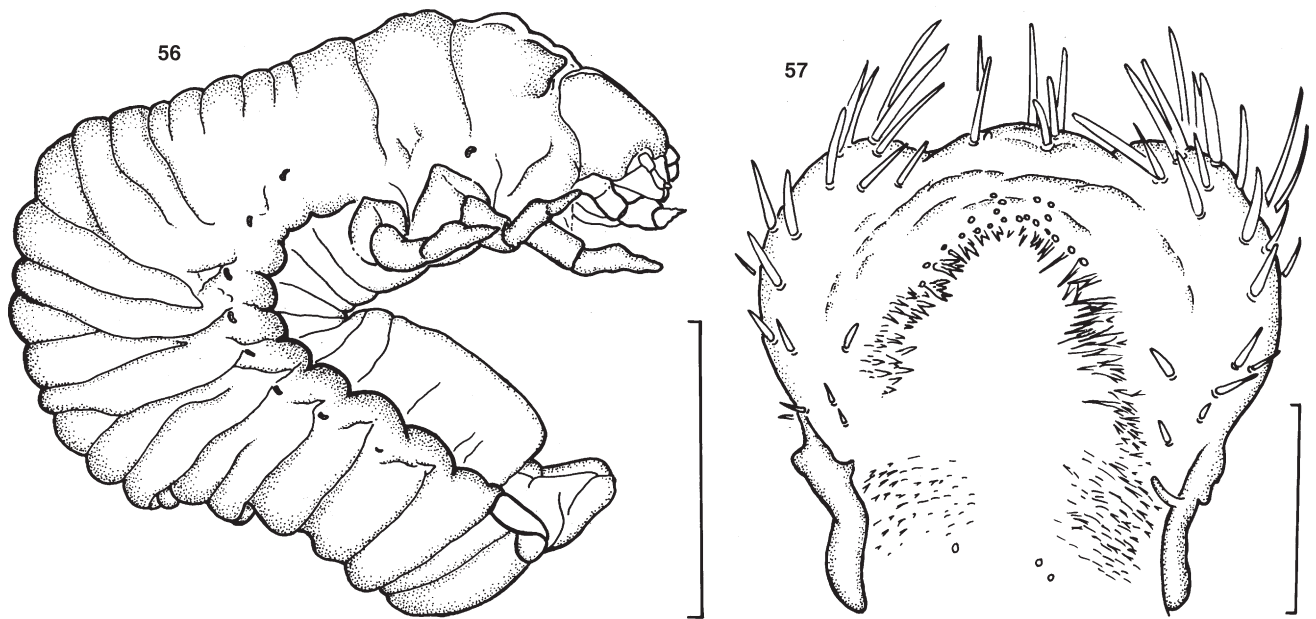

Figs 56–57. Mature larva of *Sceliages hippias*. 56, Habitus, lateral view, scale bar: 5 mm; 57, epipharynx, scale bar: 0.2 mm.

setae; distal segment with three apical conical sensillae and nine pores on ventral surface. Mandible (Figs 62–67): nearly symmetrical; scissorial part on right mandible markedly shorter than that on left one; each mandible with three groups of short setae in molar part and with one long seta in proximal third of lateral surface. Maxilla (Fig. 69): dorsal surface of stipes without irregular row of conical teeth along basal margin. Labium and hypopharynx (Fig. 69): hypopharyngeal bracon as on Fig. 69; hypopharynx without oncyli. Thorax (Figs 77): pro- and metathorax not subdivided by folds; mesothorax weakly subdivided dorsally. Tergum of prothorax with anterior process on each side. Mesothoracic spiracles not found. Legs (Figs 73–76): two-segmented, with weak additional dorsal fold between presumably trochanter and femur. Abdomen (Fig. 56): segments 1–5 subdivided dorsally in three dorsal lobes; segment 6 subdivided in two dorsal lobes; segments 7–10 not subdivided. Anal opening transverse (Fig. 79). Raster absent.

Remarks and discussion

Sceliages hippias larvae resemble those of dung-feeding Scarabaeinae groups. They share a number of morphological characters outlined by Edmonds and Halffter (1978; with a few exceptions, see description). In the current paper we outline some of the major characters of *Sc. hippias* larvae and compare them to the larvae of other taxa of the Scarabaeinae. Putative phylogenetic trends are discussed below.

(1) Tormae and their associated sclerites (epitorma, dexiotorma, laeotorma, pternotorma) are markedly

reduced or absent. These structures are normally present throughout larvae of the Scarabaeoidea (Ritcher 1966; Edmonds and Halffter 1978). In some cases tormae are not united mesally or are somewhat reduced (Ritcher 1966; Schuster and Reyes-Castillo 1981). As far as we are aware, the degree of reduction of the tormae in larval *Sc. hippias* is the most extreme within the subfamily.

- (2) The dorsal surface of the stipes is without an irregular row of conical teeth along the basal margin. These teeth are present throughout Scarabaeinae (except *Sisyphus*; see Edmonds and Halffter 1978) and many other groups in the Scarabaeoidea. We are not aware of a study demonstrating homology in these structures between the different lineages of the Scarabaeoidea. Occasionally these teeth are referred to as stridulatory teeth (Ritcher 1966: 26). This assumption has been doubted by Edmonds and Halffter (1978: 313). Moreover, Hirschberger and Rohrseitz (1995) were not able to detect any sound pattern from *Aphodius* larvae possessing these teeth (P. Hirschberger, personal communication).
- (3) The hypopharyngeal area is without oncyli. Hypopharyngeal sclerotisation is present in all known larvae of the subfamilies Scarabaeinae and Aphodiinae. Hypopharyngeal sclerotisation is also present in the larvae of the families Geoptrupidae and Lucanidae. As with the presence of 'stridulatory' teeth on the stipes, no proof has been found to demonstrate the homology of these structures in the different groups of the Scarabaeoidea. The absence of these sclerites in

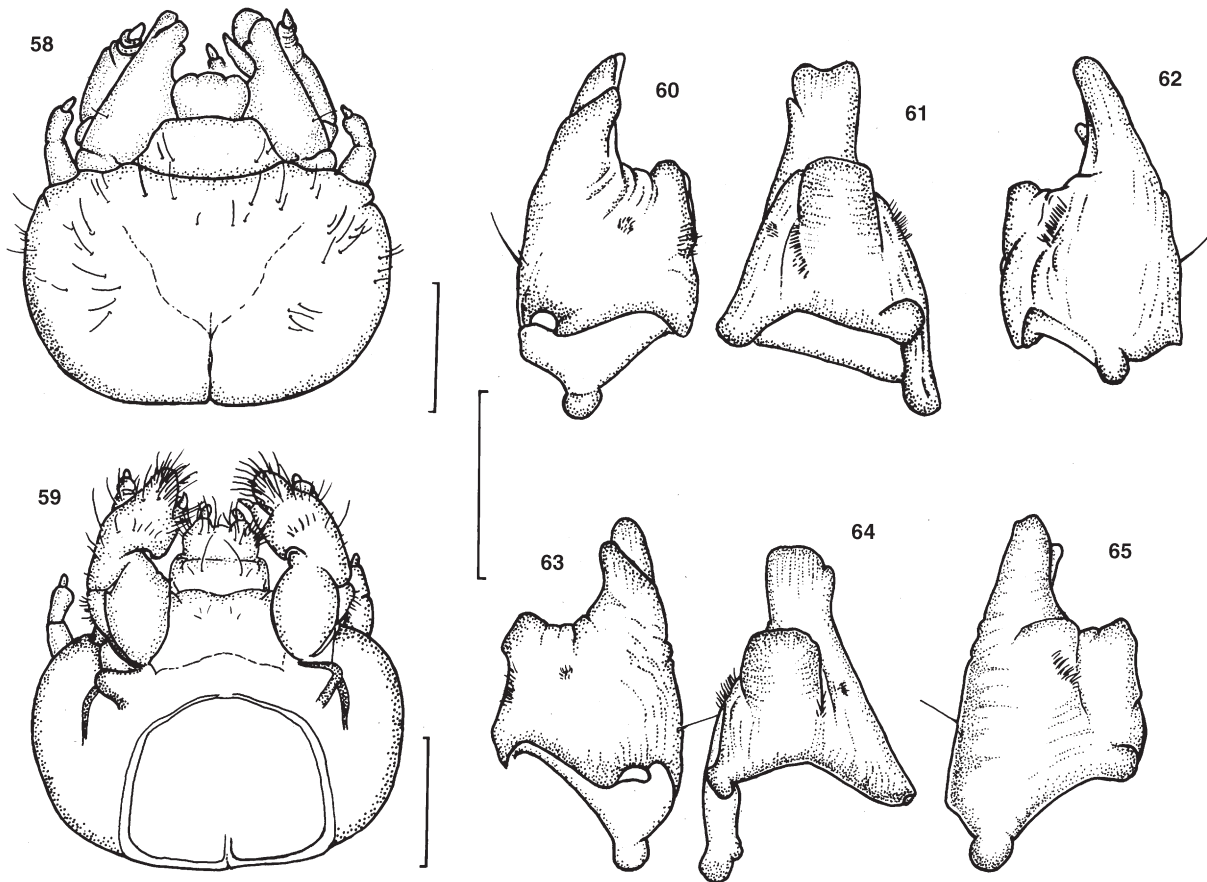

Figs 58–65. Mature larva of *Sceliages hippias*, details. Scale bars: 1 mm. 58, Head, dorsal; 59, head, ventral; 60, left mandible, dorsal; 61, left mandible, mesal; 62, left mandible, ventral; 63, right mandible, dorsal; 64, right mandible, mesal; 65, right mandible, ventral.

Sc. hippias larvae appears to be unique within the subfamily.

- (4) The antennae of *Sc. hippias* larvae consist of three antennomeres. In contrast, all other described larvae within the Scarabaeinae possess four antennomeres, even when the subdivision between the two basal segments is poorly distinguished. In *Sc. hippias*, this subdivision is absent and, consequently, the two basal antennomeres are fused to form a single one. A three-segmented antenna is a character often utilised to separate Geotrupidae larvae from those of Scarabaeinae possessing four-segmented antennae. Three-segmented antennae have also been found in one unidentified *Scarabaeus* larva from South Africa (Grebennikov and Scholtz, unpublished data).
- (5) The raster is absent from the ventral surface of the last abdominal segment of *Sc. hippias*. This structure is often inconspicuous, but still present in larvae of the Scarabaeinae (except larvae of the genus *Sisyphus*; Edmonds and Halffter 1978). We failed to see any setation on the median part of the tenth ventrite, even under high magnification.

Biology and nidification

Millipedes

Three relatively abundant species of millipedes from the order Spirostreptida are utilised by *Sc. hippias* at the Rustenberg Nature Reserve. Two species belong to the family Spirostreptidae: *Doratogonus rugifrons* (Attems 1922) and *D. levigatus* (Attems 1928). The former is a large black species approximately 12–14 cm long and 4–11 mm wide. The latter species is approximately 8–11 cm long and 5–7 mm wide. The third large orange/brown-banded species, *Zinophora robusta* (Attems, 1928), with similar dimensions to *D. levigatus*, belongs to the family Harpagophoridae.

Attraction to millipedes

It was important to confirm whether attraction to millipedes by *Sceliages* beetles is primarily due to a positive chemotactic response to the quinone-based secretions produced by the millipedes (Krell *et al.* 1998). To provisionally test this, healthy, uninjured *Z. robusta* and *D. rugifrons* millipedes were wrapped in pieces of tissue paper and agitated to collect their quinone-based secretions (after Krell *et al.* 1997).

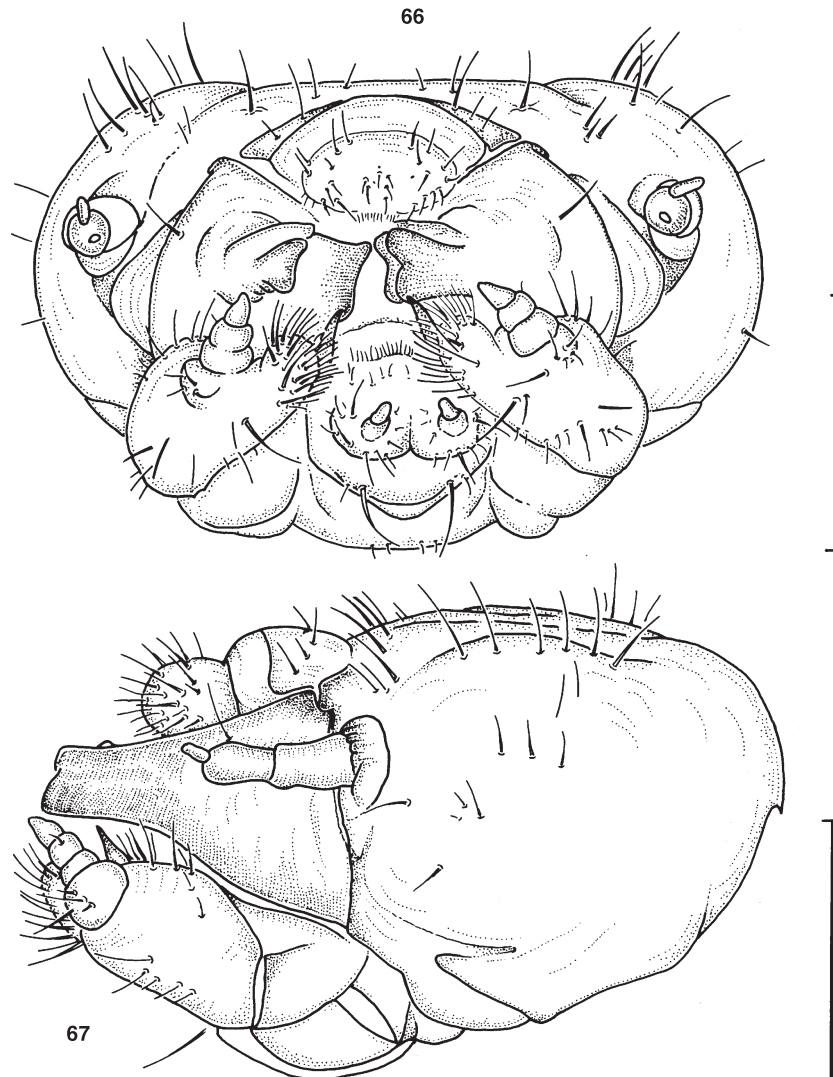

Figs 66–67. Mature larva of *Sceliages hippias*, details. Scale bars: 1 mm. 66, Head, frontal; 67, head, lateral.

These pieces of tissue (including a control piece of tissue paper not containing secretions) were then suspended above three pitfall traps and left for approximately 1/2 an hour at 1000 hours. Only the 'quinone' traps collected several adult *Sceliages*. A healthy, uninjured millipede suspended above a pitfall trap also attracted four adults of *Sceliages* within 1/2 an hour. Other species of beetles known to utilise millipede carcasses in the research area were not attracted to the traps.

Millipede relocation

We tested the assumption that *Sceliages* make balls from the internal tissues of a freshly crushed millipede and roll the ball backwards using its forelegs for locomotion. We crushed several millipedes and left them for observation. Beetles, instead of making a ball, utilised the freshest and most intact portion of the millipede, which was relocated using their

head and forelegs. Whole millipede corpses and injured millipedes were relocated in the same way up to a distance of 5 m.

Burial

Laboratory trials were set-up using six pairs of *Sc. adamastor* to observe male-female co-operation in millipede burial. Fighting took place when a single millipede corpse was introduced to each pair. When a second millipede corpse was added to each pair, relocation and burial were carried out individually. Similarly, no male-female cooperation of *Sc. hippias* was observed in the field.

In Rustenberg Nature Reserve, six females of *Sc. hippias* were each given a whole millipede carcass in order to observe burial behaviour and to obtain larvae. Locations of each burial site were tagged and recorded using global

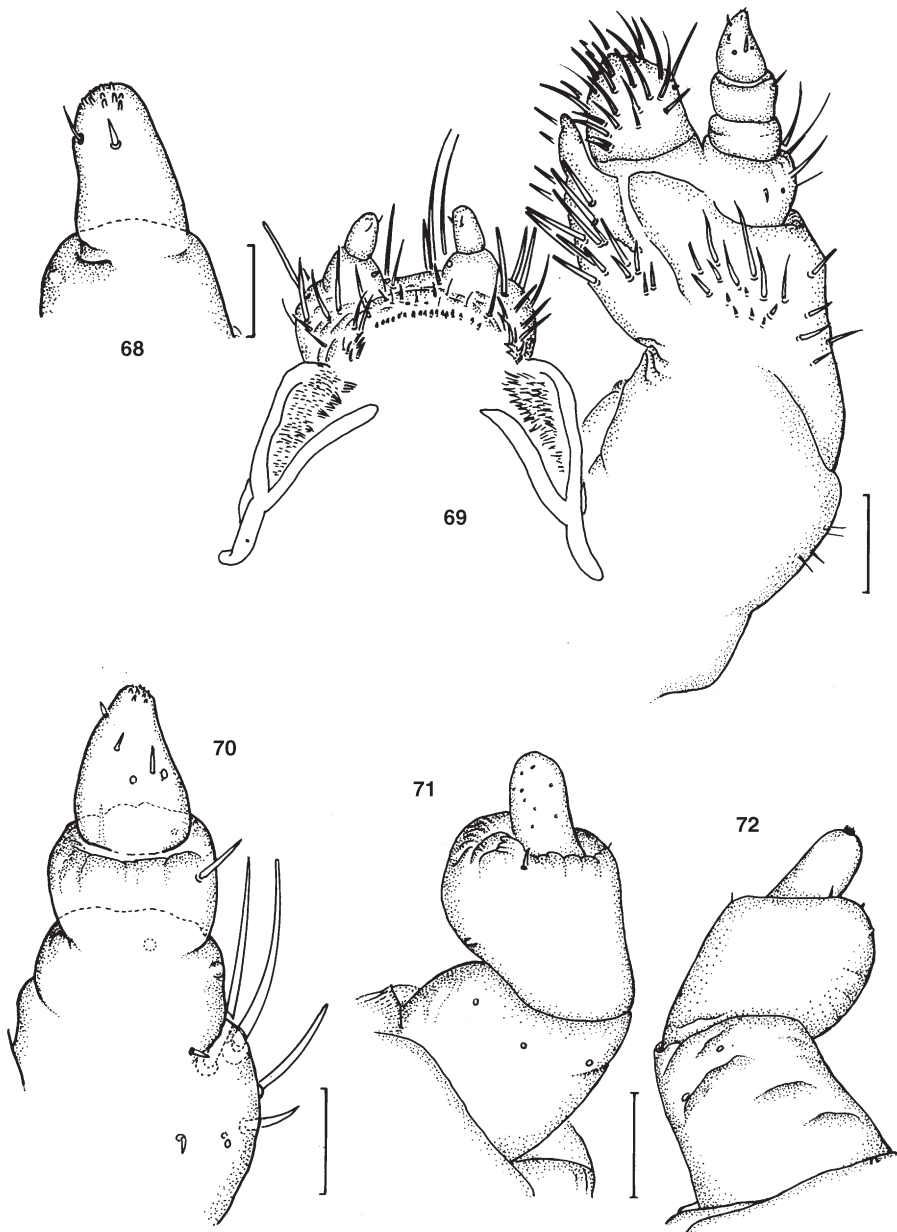

Figs 68–72. Mature larva of *Sceliages*, details. 68, Right apical labial palpomere, dorsal, scale bar: 0.01 mm; 69, labium, hypopharynx and right maxilla, dorsal, scale bar: 0.25 mm; 70, right maxillary palp, dorsal, scale bar: 0.1 mm; 71, left antenna, ventral and 72, left antenna, dorsal, scale bar: 0.1 mm.

positioning system. Two burial techniques were observed. (1) *Sceliages hippias* excavates directly in front of the millipede corpse and draws it into the tunnel as it is excavated. Initially, this is carried out by undermining the millipede either directly underneath or at an angle at one end of the millipede. Tunnels constructed by *Sc. hippias* are relatively straight and excavated at a 30° angle. (2) A female of *Sc. adamastor* was observed at the De Hoop Nature reserve excavating a tunnel wide enough for both beetle and millipede to fit. Once the tunnel was started, the beetle

aligned the millipede lengthways at its entrance and pushed the millipede in gradually from behind making directional and postural adjustments of the corpse using its head.

Six burial sites were excavated one month later. Four sites contained vacant burrows and/or chambers containing the empty, disarticulated segments of the millipedes presented to the beetles a month earlier. Two sites contained brood chambers with balls and an accompanying adult female. Each brood ball contained a third-instar larva. Chambers were found at a depth of 7 to 14 cm beneath the surface. The

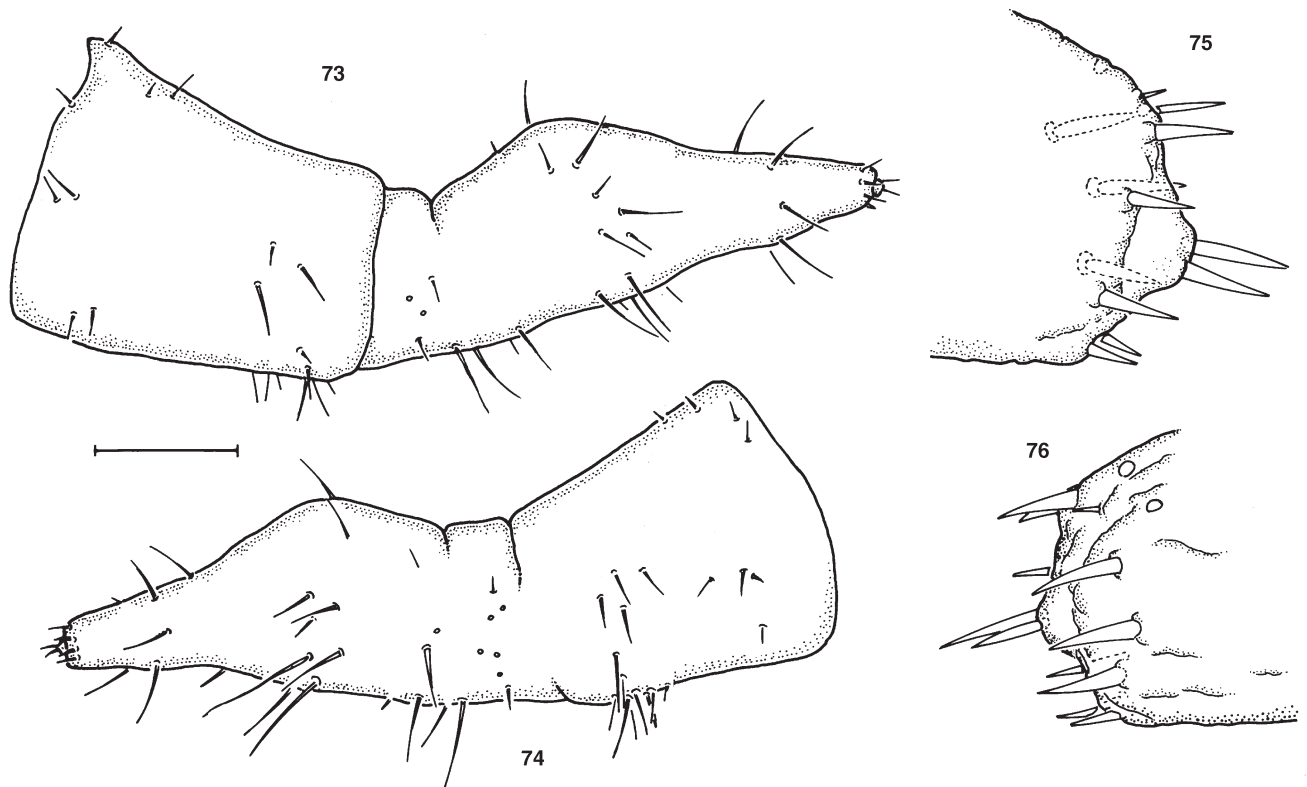

Figs 73–76. Mature larva of *Sceliages hippias*, details. Scale bars: 0.4 mm. 73, Left leg, anterior; 74, left leg, posterior; 75, apex of left leg, anterior; 76, apex of left leg, posterior.

tunnel leading to each chamber, and the entrance side of the chambers themselves, were filled with empty, separated millipede exo-skeletal body segments.

Brood balls

Millipedes of different sizes were measured to see how many balls a reproducing female of *Sc. hippias* could make from them. Beetles presented with millipedes up to 7 mm in diameter produced a single brood ball. Millipedes around 11 mm in diameter yielded two brood balls. Three millipedes between 7 and 8 mm in diameter were presented to a single female to test whether she could utilise the entire resource and produce more than the standard one or two brood balls from a single millipede. Four weeks later, the same female was recovered brooding three balls: two balls containing third-instar larvae; and a third with a second-instar larva. Brood balls are pear-shaped. The ball is encapsulated by a compact protective layer of soil up to 3.5 mm thick. Soil is also used to make an egg chamber on the side of the ball. The larval food ball of *Sc. hippias* is approximately 12 mm in diameter and constructed from the internal tissues, intestinal dung and remnant chitinous pieces of the millipede.

Addition of a compacted soil substrate occurs within the brood chamber and is thought to prevent desiccation and protection against pathogens (Halffter and Matthews 1966). Parental brooding by female *Sceliages* occurs in conjunction

with the soil-encrusted balls, a behaviour different to that described for the majority of the Scarabaeini that were thought not to brood or encrust balls with soil (Halffter and Edmonds 1982: 40).

Phylogenetic analysis of the genus *Sceliages* Westwood

Methods

Taxa

A cladistic analysis was performed including all seven species of *Sceliages*. Ingroup-taxa character states were polarised against two species of *Scarabaeus*, *S. zambesianus* Péringuey, 1908 and *S. rusticus* (Boheman, 1857). Outgroup selection was based on a preliminary combined morphological and molecular phylogenetic analysis of the tribe by Forgie, Philips and Scholtz (unpublished data), taking into consideration arguments by Nixon and Carpenter (1993). Twenty-seven characters (including three multi-state) were coded from the sclerotised external structures of teneral adults. The aedeagus and virgular sclerite of the internal sac were also utilised (see Materials and methods, 'Male genitalia' for preparation). Larval characters were not used owing to a lack of material. Morphological characters and their states were described using the terminology of Doyen (1966) and Lawrence and Britton (1991).

Phylogenetic analysis

A character matrix was compiled in DADA, version 1.2.7 (Nixon 1998). *Sceliages hippias* has several interesting character states (i.e. character 0/state 1, 16/0, 19/0 and 21/0), which it shares with at least one of the outgroup taxa. These states are either plesiomorphic or were convergently evolved. Sympleisomorphies are also present in *Sc.*

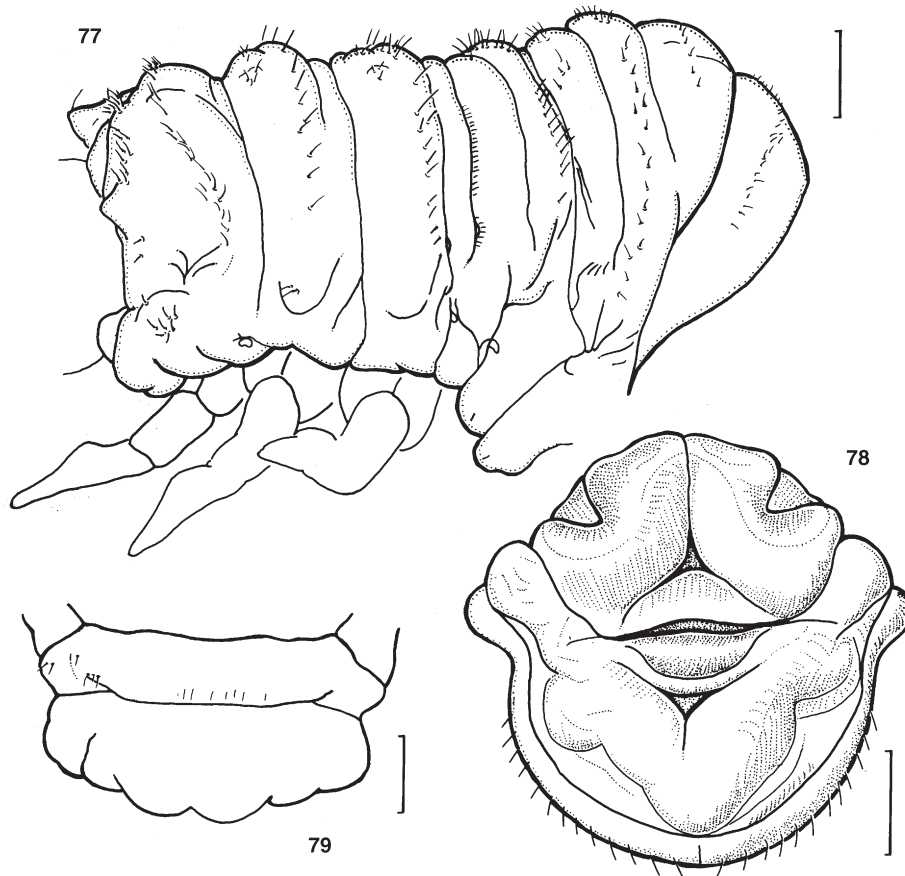

Figs 77–79. Mature larva of *Sceliages hippias*, details. Scale bars: 1 mm. 77, Thorax and two first abdominal segments, lateral; 78, venter of last abdominal segment; 79, anal opening and anal lobes.

adamastor (26/0) and *Sc. brittoni* (24/0). Autapomorphic character states, although informative in describing the uniqueness of each species, are uninformative in the analyses and bias the consistency and retention indices by having zero homoplasy. Autapomorphic character states were therefore avoided during coding and their absence was confirmed using the mop-up option in DADA. Character states unique to *Sceliages* are informative in differentiating the genus from other genera within the Scarabaeini, but are generally uninformative in a species-level phylogenetic study such as this and were therefore not coded.

All characters were spawned in NONA (Goloboff 1993) with 1000 repetitions to ensure all the shortest cladograms were found utilising

branch and bound search options with randomised taxon order in each run. A single tree found in NONA was submitted to Hennig86, version 1.5 (Farris 1988) and subjected to successive approximations weighting, hennig tree construction and branch breaker options (*xs w*, *mh**, and *bb** commands respectively). Bremer support (decay index) was calculated with NONA up to a value of 5, i.e. searching for trees up to five steps longer in the tree(s) submitted for calculation. Trees were also calculated in Parsimony and Implied Weights (PIWE), version 2.6 (Goloboff 1993, 1997). Five levels of concavity (0, 1, 2, 3 [default], 4, 5) were applied to the characters using *rs0*, *hold1000*, *hold/100*, *mult*100* commands. High repetitions run in NONA ensured the best PIWE trees were generated. All DOS-based analysis programmes were run through WinClada (BETA), version 0.9.9 (Nixon 1999a).

Consistency (CI) and retention indices (RI) (Farris 1989) are indicated for each character in the list below. A matrix of taxa and character states is provided in Table 1.

Table 1. Character states of the taxa used in the phylogenetic analysis of the genus *Sceliages* Westwood. Outgroup taxa are indicated in bold.

	1	2
	012345678901234567890123456	
<i>Scarabaeus zambesianus</i>	00000000000100000000000100	
<i>Scarabaeus rusticus</i>	100000000111000000000000001	
<i>Sceliages adamastor</i>	011110000110101011121111210	
<i>Sc. augias</i>	000001111011100010021111211	
<i>Sc. brittoni</i>	011110100111011111121111011	
<i>Sc. difficilis</i>	000110011010110121121111101	
<i>Sc. gagates</i>	000001110100110020010101101	
<i>Sc. granulatus</i>	000001111010111020010111101	
<i>Sc. hippias</i>	11111100101101100000001201	

List of characters and their states

0. *Apical antennomeres*: (0) brown to black; (1) yellow to orange. CI, 0.50; RI, 0.00.
1. *Medio-longitudinal hump-like process on clypeus*: (0) extending anteriorly; (1) absent anteriorly (clypeus *c.* flat). CI, 0.50; RI, 0.50.
2. *Geno-clypeal sutures*: (0) curved medially; (1) *c.* straight. CI, 0.50; RI, 0.50.
3. *Punctations on dorsum of head plates*: (0) uneven and irregular; (1) even and regular. CI, 0.50; RI, 0.66.
4. *Head plate dorsal surface*: (0) rugosissimus; (1) rugulosus. CI, 0.50; RI, 0.66.

5. *Lateral margins of pronotum*: (0) evenly rounded; (1) obtusely rounded. CI, 0.50; RI, 0.66.
6. '*Epipleura*' of the lateral margins of pronotum: (0) even thickness throughout; (1) not so. CI, 0.33; RI, 0.33.
7. *Indumentum on surface of elytra*: (0) absent (appearing glossy); (1) present. CI, 0.50; RI, 0.66.
8. *Elytra surface*: (0) smooth (without raised granulation or corrugation); (1) complex (with raised granulation or corrugation). CI, 0.50; RI, 0.50.
9. *Striae on elytra*: (0) markedly defined with bordering microcarinae; (1) not so. CI, 0.33; RI, 0.33.
10. *Mesobasisternum punctation*: (0) facet of puncture forming a raised tubercle-like protrusion (punctation usually crescent-shaped and may be vestigial); (1) not so. CI, 0.50; RI, 0.50.
11. *Mesobasisternum surface* (due to size, density and arrangement of punctations): (0) rugose; (1) not so. CI, 0.33; RI, 0.33.
12. *Width between sclerotised medial margins of aedeagus paramere (anterior frontal view)*: (0) uneven, widening in apical half; (1) relatively even through length. CI, 0.50; RI, 0.50.
13. *Dorsal margin at distal terminus of union between handle of virgular sclerite and circular sclerite*: (0) downward turned (slight to markedly), discontinuous with remainder of dorsal margin; (1) not downward turned, forming a continuous uninterrupted curve with remainder of dorsal margin. CI, 0.33; RI, 0.33.
14. *Baso-ventral corner of handle of virgular sclerite*: (0) forming a protruding extension (slight to markedly); (1) no protrusion. CI, 0.33; RI, 0.33.
15. *Thickness of handle of virgular sclerite*: (0) uneven, thickest at basal and/or apical termini; (1) even throughout. CI, 0.30; RI, 0.00.
16. *Anterior-ventral margin of profemora adjacent to protrochanter*: (0) uniform and unmodified; (1) armed with markedly developed spur; (2) armed with a vestigial spur. CI, 0.66; RI, 0.75.
17. *Width of protibia*: (0) progressive increase in width from thinnest proximally to thickest distally; (1) abrupt increase in width distally between second and third external denticle. CI, 1.00; RI, 1.00.
18. *Inward angulation of medial facet of protibia*: (0) between or at external denticles 1 and 2; (1) between external denticles 2 and 3 or at external denticle 3. CI, 1.00; RI, 1.00.
19. *Setae on posterior surface of mesofemora*: (0) forming a single evenly spaced row of setae paralleling ventral margin; (1) forming two even rows of individually positioned setae (not clustered) parallel to dorsal and ventral margins with a medial third row containing fewer setae present or not; (2) three or more uneven rows of evenly or unevenly spaced setae. CI, 1.00; RI, 1.00.
20. *Setation on posterior surface of mesofemora*: (0) sparse; (1) dense. CI, 1.00; RI, 1.00.
21. *Shape of mesotibia*: (0) uncurved; (1) curved inwards. CI, 1.00; RI, 1.00.
22. *Tapering/truncation through length of mesotibia*: (0) even; (1) uneven, truncation in apical half or third. CI, 1.00; RI, 1.00.
23. *Number of mesotibial spurs*: (0) one; (1) two. CI, 1.00; RI, 1.00.
24. *Length of major (or outer) mesotibial spur*: (0) c. 1/2 length of mesotibia; (1) c. 1/3 length of mesotibia; (2) much less than 1/3 length of mesotibia. CI, 0.40; RI, 0.00.
25. *Length of mesotarsi*: (0) c. 2/3 length of mesotibia; (1) less than 2/3 length of mesotibia. CI, 0.50; RI, 0.50.
26. *Curvature of metatibia*: (0) markedly bowed inwards; (1) c. straight. CI, 0.50; RI, 0.00.

Results and discussion

Unweighted v. weighted trees

A single most parsimonious tree generated with unweighted data had a length of 58 steps and consistency and retention

indices of 0.51 and 0.57 respectively (Fig. 80). Weighting of data was applied two ways, successively in Hennig86 (Farris 1988), and in PIWE (Goloboff 1997), with the latter assigned five levels of weight (1–5) towards character homoplasy (see Goloboff 1993). Both methods generated single trees with identical ingroup topologies. In addition, there were no differences in the ingroup topologies between weighted and unweighted analyses. *Scarabaeus rusticus* always appears as sister to the *Sceliages s. str.* clade in all trees except the successive approximations weighting tree in which a basal trichotomy occurs.

Tree support

While the data is obviously very stable, low overall Bremer support in the tree topology is likely to result from a low number of characters and the relatively high consistency and retention indices (CI, 0.51; RI, 0.57) generated (Fig. 80). One of the highest Bremer values in the tree topology supports the genus, thereby indicating its monophyly. Very high Bremer support and bootstrap values support the monophyly of *Sceliages* in morphological and molecular phylogenetic studies of the Scarabaeini (Forgie, Philips and Scholtz and Forgie, Bloomer & Scholtz, unpublished data). The apical *Sc. brittoni* and *Sc. adamastor* clade also shares greater support than the remaining nodes of the tree. This close relationship is also well supported in both of the above phylogenetic studies by Forgie *et al.* (unpublished data). Four characters (i.e. 0, 15, 24, 26) had retention indices of zero, suggesting their states were uninformative and therefore unable to support the branch topology of the species in the genus. Their deactivation did not significantly improve the decay indices but resulted, as would be expected, in the construction of a slightly more parsimoniously robust tree (length 46 steps; CI, 0.54; RI, 0.64). The topology of the new unweighted NONA tree remained unchanged, again indicating good stability of the data.

Evolutionary trends

Regardless of which method is used to discover topologies/trees, the same ingroup relationships are found. The genus *Sceliages* is differentiated from *Scarabaeus L. s. l.* in this phylogeny by four synapomorphic character states (5/1, 6/1, 12/1, 23/1), of which character state 23/1 is the only non-homoplasious synapomorphy (Fig. 80). All species of *Sceliages* have a second mesotibial spur (23/1) that is markedly developed. The development of the second spur is unique within the Scarabaeini and is likely to play a functional role in the utilisation of millipedes, such as aiding grip and leverage on the smooth surface of the millipede as it is being discarticulated. A second spur, however, is not unique to *Sceliages*, having evolved polyphyletically at least two other times within the Scarabaeini (Forgie, Philips and Scholtz, unpublished data). A second spur is also present (albeit vestigial) in *Scarabaeus* subgenus *Scarabaeolus s. str.*

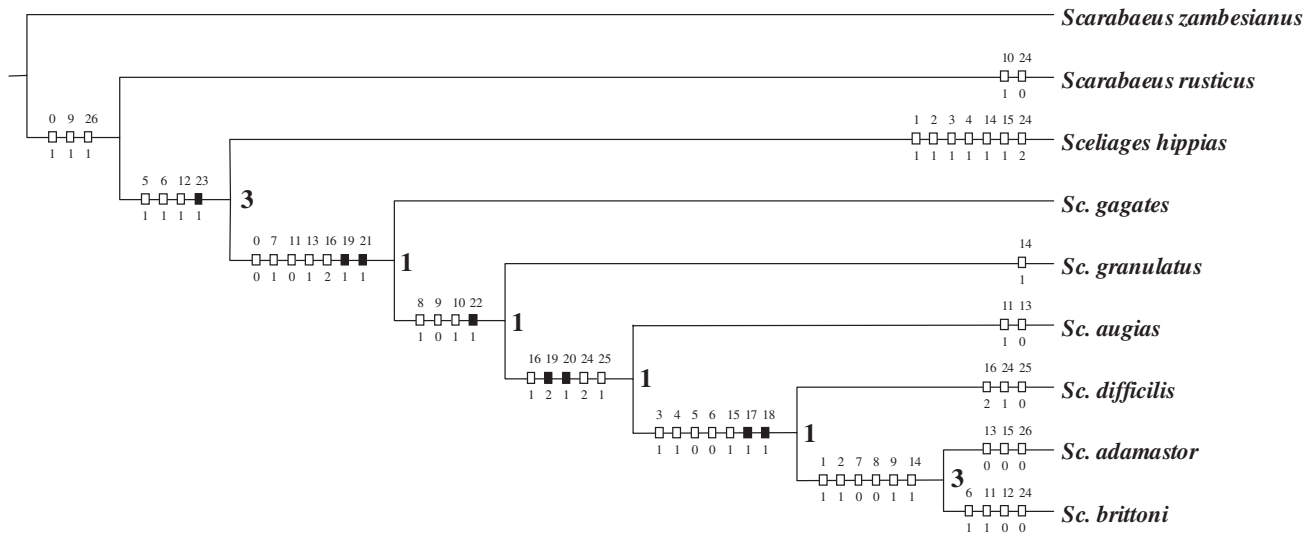

Fig. 80. Hypothesised relationships among species of *Sceliages* (*Sc.*) Westwood (Coleoptera: Scarabaeidae) represented by single NONA tree (length 58 steps; CI, 0.51; RI, 0.57). Black squares indicate non-homoplasious changes (synapomorphies or autapomorphies), white squares indicate homoplasies. Numbers above squares represent character, numbers below squares represent character states (Nixon 1999b). Bremer support indices (in bold) are provided next to each ingroup node.

Balthasar, 1965 species, *S. silenus* (Gray 1832) and *S. (Scarabaeolus) scholtzi* (Mostert and Holm 1982) of the Scarabaeini and also in some members of the Gymnopleurini (Mostert and Scholtz 1986).

Sceliages adamastor, *Sc. brittoni* and *Sc. difficilis* show a reversal in the lateral margin of the pronotum from an obtusely rounded condition (5/1) back to an evenly rounded plesiomorphic condition (5/0), the latter shared by many species of the Scarabaeini (Forgie, Philips and Scholtz, unpublished data). Similarly, *Sc. adamastor* and *Sc. difficilis* both show a reversal in the epipleural condition of the pronotum lateral margin, from a derived uneven thickness throughout (6/1) to epipleura that are unvaried or even in thickness (6/0). The shape of the aedeagus of *Sceliages* is largely identical to that of the majority of the *Scarabaeus* species, a condition thought by Mostert and Scholtz (1986) to be due to convergence rather than synapomorphy. However, a single character state coded from the aedeagus parameres is synapomorphic to the genus; all species of *Sceliages*, with the exception of *Sc. brittoni*, have a relatively even width between the sclerotised medial margins of the aedeagus parameres (12/1). Only *Sc. brittoni* exhibits a reversal to the ancestral condition (12/0).

Sceliages hippias represents the most basal species for the genus and is differentiated from the remaining clade by several apomorphic character states, which it also shares with one or both outgroup taxa. These include: yellow antennomeres (0/0); a uniform and unmodified antero-ventral margin of the profemora adjacent to the protochanter (16/0); a single, uniform row of setae paralleling the ventral margin of the posterior facet of the mesofemora (19/0); and uncurved mesotibiae (21/0).

Setation on the posterior surface of the mesofemora evolved from a plesiomorphic condition of one row (19/0) to two rows with a medial and sparsely pubescent third row present or not (19/1), to 3 or more uneven rows of setae (19/2), which is a synapomorphy for *Sc. augias* (Casonda, Angola exemplar), *Sc. difficilis*, *Sc. adamastor* and *Sc. brittoni*. Such a condition, although variable in development both intra- and inter-specifically, evolved after the shift to millipede necrophagy since the plesiomorphic condition persists in *Sc. hippias*, the most ancestral member of the genus. The function of increased pubescence is unclear when sparsely pubescent species such as *Sc. hippias* are as successful in millipede necrophagy as species like *Sc. brittoni* that have dense pubescence on the posterior surface of the mesofemora.

A waxy indumentum on the surface of the elytra (7/1) is synapomorphic for the clade excluding *Sc. hippias*, *Sc. adamastor* and *Sc. brittoni*. The latter two species exhibit an evolutionary reversal back to the ancestral condition where a waxy indumentum is lacking (7/0). The semi-arid species, *Sc. granulatus*, exhibits the highest degree of wax indumentation in the genus and the coastal species, *Sc. gagates*, exhibits the least. Such a condition aids in the reduction of cuticular transpiration (Ward and Seely 1996) and, when viewed in a broader phylogenetic sense, is homoplastic at least within the Scarabaeini (Forgie, Philips and Scholtz, unpublished data) and Tenebrionidae (e.g. Ward and Seely 1996).

The dorsal margin at the terminus of the union between the handle of the virgular sclerite and circular sclerite forms a continuous, uninterrupted curvature with the remainder of

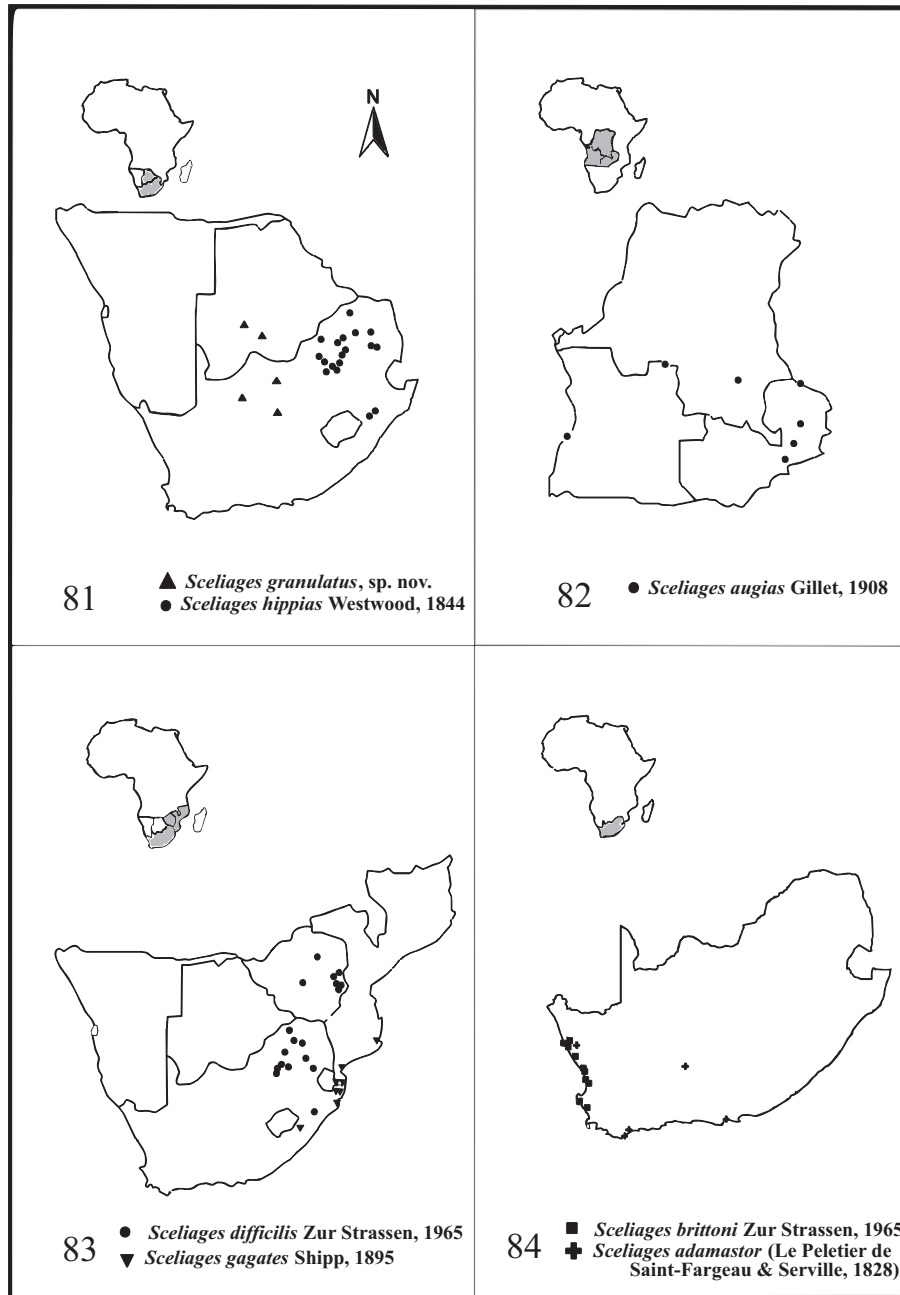

Figs 81–84. Distribution maps of *Sceliages* species in southern Africa.

the dorsal margin (13/1) in the species of *Sceliages*, with the exception of *Sc. hippias*, *Sc. augias* and *Sc. adamastor*. This synapomorphic state is reversed, in the latter two species, to the ancestral condition in which a downward turn of the dorsal margin occurs at the terminus of the union between the handle of the virgular sclerite and circular sclerite (13/0). The virgular sclerite of the internal sac of the male genitalia tends to be highly conserved and useful for assigning reliable apomorphic character states (Medina 2000), but may be

relatively uninformative for phylogenetic analyses. A consistency value of 0.33 indicates a relatively high level of homoplasy for this character.

Distribution

The ancestral lineage of *Sceliages* was distributed centrally within the geographical range of the genus from which subsequent lineages dispersed, morphologically adapting to the habitats they are currently distributed in (Figs 81–84).

The sister relationship of *Sc. adamastor* + *Sc. brittoni* is reflected in their sympatric distributions (Fig. 84). Both species are adapted to similar habitats and exhibit the most congruency in derived morphological character states in the genus. The phylogenetic derivation of the common ancestor of *Sc. adamastor* and *Sc. brittoni* from that leading to *Sc. difficilis* is biogeographically feasible, with a break between a north-eastern extension of the ancestral populations of the common ancestor of these species. The topological positioning of the remaining members of the genus as successive sisters to one another suggests their radiation from the ancestral lineage, leading to *Sc. hippias*, occurred on several independent occasions.

Concluding remarks

The majority of external morphological characters of *Sceliages* are shared with the genus *Scarabaeus*, however, a few synapomorphic character states are unique to *Sceliages* (see 'Diagnosis' of the genus). The presence of a second mesotibial spur in this phylogenetic study appears as the single unique character state, yet it is present in other members of the Scarabaeini including *Scarabaeus s. str.* However, the degree of development of the second spur in *Sceliages* is unique. Moreover, although necrophagy in the Scarabaeini is not unique to *Sceliages*, the apparent obligate utilisation of millipedes is and further strengthens the monophyly of the genus. Mostert and Scholtz (1986) likened *Sceliages* as the genus closest to the hypothetical common ancestor of the genera of the Scarabaeini, having undergone the least morphological evolution. In contrast, a current phylogenetic analysis of the Scarabaeini by Forgie *et al.* (unpublished data) suggests the genus *Sceliages* is among the more derived members of the tribe. Evidence from both studies support the monophyly of the genus.

In this paper we were able to describe some behavioural characteristics of the adult beetles provisioning nests with millipedes for nidification. Many questions, however, remain unanswered: We know quinonous secretions of millipedes are responsible for attracting *Sceliages*, however, this was tested by stimulating a defensive reaction by millipedes. In a natural situation, are *Sceliages* beetles attracted to these secretions produced as allomones in response to the millipede being threatened or injured, and/or to these secretions being used as pheromones during millipede mate attraction and copulation? Do *Sceliages* beetles kill uninjured millipedes they may have been attracted to, or, must they rely solely on the demise of injured millipedes? Is *Sceliages* truly an obligate necrophage or are other food types also utilised? Are millipedes utilised for maturation feeding or nuptial courtship? Exactly how is the millipede disarticulated? A leverage action using the clypeal teeth and protibial external denticles is inferred (Villalobos *et al.* 1998), but has not been witnessed. We hope that these questions will stimulate further study on the biology of *Sceliages*.

Acknowledgments

The authors would like to make special thanks to Darren Mann and to Frank Krell for assisting with location of type specimens, and also Keith Philips and Frank Krell for helpful comments on the manuscript. Ute Kryger and Sybille Gussmann translated parts of zur Strassen's 1965 revision of the genus *Sceliages* into English. Barend Erasmus assisted with the species distribution maps. Michelle Hamer identified the species of millipedes utilised by *Sceliages hippias* and *Sc. adamastor*. Claudia Medina helped with fieldwork of *Sc. hippias*. Thanks to the museum curators responsible for issuing loan material: M. Kerley (BMNH); T. Crouch (DMSA); D. Mann (HECO); D. Drugmand (ISNB); M. Cochrane (SAMC); R. Stals (SANC); and J. du G. Harrison (TMSA). Thanks also to Richard Newberry (North-west Parks and Tourism Board) and Magda Goosen (Rustenberg Nature Reserve) for permitting research of *Sc. hippias* in the Rustenberg Nature Reserve, Andre Olwage for the habitus illustration of *Sc. granulatus* and Pam Prowse for inking the illustrations. This research was funded by National Research Foundation of South Africa and the University of Pretoria.

References

- Baker, C. W. (1968). 'Larval Taxonomy of the Trogidae in North America with notes on Biology and Life History (Coleoptera: Scarabaeidae). United States National Museum Bulletin 279. (US Government Printing Office: Washington, DC, USA.)
- Balthasar, V. (1961). Zwei neue Gattungen der Familie Scarabaeidae (Coleoptera). (107 Beitrag zur Kenntnis der Scarabaeidae). *Entomologische Arbeiten aus dem Museum Georg Frey* **12**, 174–181.
- Boheman, C. H. (1857). *Insecta Caffrariae*, 2 (Scarabaeides). (Nordstedt: Holmia, Sweden.)
- Böving, A. G. (1936). Description of the larva of *Plectrus aliena* Chapin and explanation of new terms applied to the epipharynx and raster. *Proceedings of the Entomological Society of Washington* **38**(8), 169–185.
- Cano, E. B. (1998). *Deltotilum valgum acropyge* Bates (Coleoptera: Scarabaeidae: Scarabaeinae): habits and distribution. *The Coleopterists Bulletin* **52**(2), 174–178.
- Doyen, J. T. (1966). The skeletal anatomy of *Tenebrio molitor* (Coleoptera: Tenebrionidae). *Miscellaneous Publications of the Entomological Society of America* **5**, 103–150.
- Edmonds, W. D., and Halfpeter, G. (1978). Taxonomic review of immature dung beetles of the subfamily Scarabaeinae (Coleoptera: Scarabaeidae). *Systematic Entomology* **3**, 307–331.
- Farris, J. S. (1988). 'Hennig86, Version 1.5.' (Published by the author: Port Jefferson Station, New York, USA.)
- Farris, J. S. (1989). The retention index and the rescaled consistency index. *Cladistics* **5**, 417–419.
- Felsche, C. (1910). Über coprophage Scarabaeiden. *Deutsche Entomologische Zeitschrift* **1910**, 339–352.
- Ferreira, M. C. (1961). Catálogo dos Escarabídeos da região etíópica. Tribos Scarabaeini, Gymnopleurini e Oniticellini. *Boletim da Sociedade Portuguesa de Ciências Naturais* 2nd series **7**, 225–236; **8**, 17–157.
- Ferreira, M. C. (1967). Os escarabídeos de Moçambique. I. *Revista de Entomologia de Moçambique* **10**(1–2), 5–778.

- Ferreira, M. C. (1972). Os escarabédeos de África (sul do Sáara). I. *Revista de Entomologica de Moçambique* **11**, 5–1088.
- Gillet, J. J. E. (1908). Coprides d'Afrique tropicale. *Mémoires de la Société Entomologique de Belgique* **16**, 63–82.
- Gillet, J. J. E. (1911a). Scarabaeidae, Coprinae 1. In 'Coleopterorum Catalogus.' Part 38. (Eds W. Junk and S. Schenkeling.) (W. Junk: Berlin, Germany.)
- Gillet, J. J. E. (1911b). Coprophaga Africana. Descriptions d'especes nouvelles et remarques diverses. *Annales de la Société Entomologique de Belgique* **55**(11), 308–312.
- Goloboff, P. A. (1993). 'NONA, Version 1.6.' (Published by author: Instituto Miguel Lillo, Tucumán, Argentina.)
- Goloboff, P. A. (1997). 'PIWE, Version 2.6 (1993–1997).' (Published by the author: Instituto Miguel Lillo, Tucumán, Argentina.)
- Haacker, U. (1974). Patterns in communication in courtship and mating behaviour of millipedes (Diplopoda). *Symposia of the Zoological Society of London* **32**, 317–328.
- Halffter, G., and Edmonds, W. D. (1982). 'The Nesting Behaviour of Dung Beetles (Scarabaeinae): An Ecological and Evolutive Approach.' Publication 10. (Instituto de Ecología: Xalapa, México.)
- Halffter, G., and Matthews, E. G. (1966). The natural history of the dung beetles of the subfamily Scarabaeinae (Coleoptera: Scarabaeidae). *Folia Entomologica Mexicana* **12–14**, 1–312.
- Hanski, I., and Camberfort, Y. (1991). 'Dung Beetle Ecology.' (Princeton University Press: Princeton, New Jersey, USA.)
- Hirschberger, P., and Rohrseitz, K. (1995). Stridulation in the adult dung beetle *Aphodius ater* (Coleoptera: Aphodiidae). *Zoology* **99**, 97–102.
- Horn, W., Kahle, I., Friese, G., and Gaedike, R. (1990). 'Collectiones entomologicae. Ein Compendium ueber den Verbleib entomologischer Sammlungender Welt bis 1960.' 2 vols. (Berlin Akademie der andwirtschaftswissenschaften der Deutschen Demokratischen Republik.)
- Kon, M., Ochi, T., Nabhitabata, J., Araya, K., and Matsui, M. (1998). Necrophagous scarab beetles (Coleoptera, Scarabaeidae, *Onthophagus*) attracted to a diplopod copulating pair (Diplopoda) in Thailand. *Elytra* **26**(2), 347–349.
- Krell, F. -T. (1999). Southern African dung beetles (Coleoptera: Scarabaeidae) attracted by defensive secretions of Diplopoda. *African Entomology* **7**(2), 287–288.
- Krell, F. -T., Schmitt, T., and Linsenmair, K. E. (1997). Diplopod defensive secretions as attractants for necrophagous scarab beetles (Diplopoda; Insecta, Coleoptera: Scarabaeidae). *Entomologica Scandinavica Supplementum* **51**, 281–285.
- Krell, F. -T., Schmitt, T., Dembele, A., and Linsenmair, K. E. (1998). Repellents as attractants – extreme specialization in Afrotropical dung beetles (Coleoptera: Scarabaeidae) as competition avoiding strategy. *Zoology, Analysis of Complex Systems* **101** (Supplement 1), 12.
- Lacordaire, G. (1856). 'Genera des Coléoptères. 3. Pecticornes et Lamellicornes.' (Paris, France.)
- Lawrence, J. F. (1991). Order Coleoptera (larval morphology). In 'Immature Insects. Volume 2'. (Ed. F. W. Stehr.) pp. 146–177. (Kendall/Hunt Publishing Co.: Dubuque, Iowa, USA.)
- Lawrence, R. F. (1987). 'The Centipedes and Millipedes of Southern Africa: A Guide.' (A. A. Balkema: Rotterdam, The Netherlands.)
- Lawrence, J. F., and Britton, E. B. (1991). Coleoptera (Beetles). In 'The Insects of Australia, A Textbook for Students and Research Workers'. Volume 2. 2nd Edition. (Ed. CSIRO.) pp. 543–683. (Melbourne University Press: Melbourne, Australia.)
- Le Peletier de Saint-Fargeau, A. L. M., and Serville, J. G. (1828). Scarabéides, Scarabaeides. In 'Encyclopédie Méthodique. Volume 10'. (Ed. P. A. Latreille.) pp. 348–382.
- Matthews, E. G. (1974). A revision of the Scarabaeine dung beetles of Australia. *Australian Journal of Zoology Supplementary Series* **24**, 1–211.
- Medina, C. A. (2000). 'Diagnostic and Phylogenetic Character Variation in the Genus *Canthon* Hoffmannsegg and Related Genera (Coleoptera: Scarabaeidae: Scarabaeinae).' Unpublished MSc Thesis. (Faculty of Biological and Agricultural Sciences, University of Pretoria: Republic of South Africa.)
- Mostert, L. E., and Scholtz, C. H. (1986). 'Systematics of the Subtribe Scarabaeina (Coleoptera: Scarabaeidae).' Entomology Memoir 65. (Department of Agriculture and Water Supply: Pretoria, Republic of South Africa.)
- Nixon, K. C. (1998). 'DADA, version 1.2.7, with Nixon Island Hopper (Rachet).' (Published by the author: Cornell University, New York, USA.)
- Nixon, K. C. (1999a). 'WinClada (BETA), Version 0.9.9.' (Published by the author: Cornell University, New York, USA.)
- Nixon, K. C. (1999b). 'WinClada (BETA). Preliminary Documentation for Version 0.9.9+.' (Published by the author: Cornell University, New York, USA.)
- Nixon, K. C., and Carpenter, J. M. (1993). On outgroups. *Cladistics* **9**, 413–426.
- Paulian, R. (1934). Contribution à la connaissance de la faune entomologique du Cameroun. Coléoptères coprophages de Bafoussam. *Miscellaneous Entomology* **35**, 58–61.
- Péringuey, L. (1901). Catalog of the Coleoptera of South Africa. *Transactions of the South African Philosophical Society* **12**, 21–81.
- Ritcher, P. O. (1966). 'White Grubs and their Allies. A Study of North American Scarabaeidae Larvae.' Oregon State Monographs, Studies in Entomology 4. (Oregon State University Press: Corvallis, Oregon, USA.)
- Scholtz, C. H., and Holm, E. (1985). Scarabaeoidea In 'Insects of Southern Africa'. (Eds C. H. Scholtz and E. Holm.) pp. 214–223. (Butterworths: Durban, South Africa.)
- Schuster, J. C., and Reyes-Castillo, P. (1981). New World genera of Passalidae (Coleoptera): a revision of larvae. *Anales de la Escuela Nacional de Ciencias Biológicas* **25**, 79–116.
- Shipp, J. W. (1895). The coprophagous Lamellicornia: a list of species belonging to the genera *Circellium* and *Sceliages*, with notes on Ateuchidae. *The Entomologist* **28**, 218–221.
- Villalobos, F. J., Diaz, A., and Favila, M. E. (1998). Two species of *Canthon* Hoffmannsegg (Coleoptera: Scarabaeidae) fed on dead and live invertebrates. *The Coleopterists Bulletin* **52**(2), 101–104.
- Ward, D., and Seely, M. K. (1996). Adaptation and constraint in the evolution of the physiology and behaviour of the Namib Desert tenebrionid beetle genus *Oryzopsis*. *Evolution* **7**, 1231–1240.
- Westwood, J. O. (1837). Characters of some new coleopterous insects, belonging to the family of sacred beetles. *Proceedings of the Zoological Society of London* **5**, 12–13.
- Westwood, J. O. (1844). A memoir, containing descriptions of two species of sacred beetles from Southern Africa. *Proceedings of the Entomological Society of London* **1844**, 100.
- Zur Strassen, R. (1965). Zur Kenntnis Gattung *Sceliages* Westwood, mit zwei Neubeschreibungen (Ins., Col., Scarabaeidae). *Senckenbergiana Biologica* **46**(3), 219–232.
- Zur Strassen, R. (1967). Arten-Übersicht der Gattung *Scarabaeus* Linnaeus (Scarabaeidae) mit besonderer Berücksichtigung der aethiopischen Formen. *Entomologische Blätter* **63**(3), 129–173.

Manuscript received 26 July 2001; revised and accepted 11 August 2002.